



TOKYO JAPAN

Rotating Ring Disk Electrode **RRDE-3A**

Portable Hydrogen Generator **H2G1**

Spectrometer system **SEC2020**

Variety of products for electrochemical research



C3 PROZESS- UND
ANALYSENTECHNIK



Electrochemistry & Spectroelectrochemistry

1

Instrumentation **1**

2

Reference Electrodes **6**

3

Working Electrodes **11**

4

Counter Electrodes **16**

5

Voltammetry Cells **17**

6

Flow Cells **20**

7

Spectroelectrochemistry **23**

8

Others **28**



• Product appearance and specifications may change without notice. • The product color could be different from the printed photos.
• The dimensions mentioned in the catalog are not guaranteed to match the dimensions of the actual products.

1

Instrumentation

RRDE-3A Rotating Ring Disk Electrode Apparatus

Detection of intermediate products by hydrodynamic voltammetry



ALS Instruments instruction manual
<https://www.als-japan.com/support-instrument-manual.html>
Manual download link

Catalog No.	Description	
013725	RRDE-3A Rotating Ring Disk Electrode Apparatus Ver.3.0	
Specification		
Rotational range	100 to 8,000 rpm	
Rotation stability	Error < 1% at 100 to 1,000 rpm < 0.5% at > 1,001 rpm	
Ring/Disk insulation resistance	> 10 M ohm	
Electrode to lead pin contact resistance	5 ohm	
Rotator shaft	Stainless steel	
Motor	12 V, ironless core, low inertial DC servo	
Power	12 V DC, external Power Supply	
Remote control	One volt corresponds to 1,000 rpm Motor ON/OFF TTL or relay input on back panel Purge TTL or relay input on back panel	
Operating temperature	10 to 50 °C	
Relative humidity	≤ 80%	
Size	190 x (Base: 230, Body: 120) x 400 mm	
Weight	3.5 kg	
Accessories		
	Qty	
(013580)	Sample vial for alkaline solution (100mL)	1
013271	RRDE-3A Teflon cap V.2	1
012064	Spin coating adapter	1
012065	Male connector for gas purge (PP)	1
013392	TYGON tubing, OD1/4" x ID1/8"	1
012642	RRDE-3A Silicon sheet 100 x 180 mm	1
012975	O-ring for RRDE-3A Bearing assembly	3
	External Power supply 12 V DC	1
	Quick Instruction manual	1

RRDA-3A is an accurate rotator system for hydrodynamic modulation rotating ring disk voltammetry. It is precisely controlled by PWM (Pulse Width Modulation). Electrodes are small and rapidly interchangeable. The unit also provides an adjustable valve system for inert gas purging inside the cell vial.

Features

- Operable as RDE and RRDE system
- Remote or manual controlled rotation speed and gas purge
- Compact design & easy operation
- Easily connects to different potentiostats
- Optional spin coating operation
- "Cleaning" and "Replacement" warning function, Software Maintenance Mode



ALS support RRDE
<https://www.als-japan.com/support-rde.html>
Support Movie link

Catalog No.	Description
013580	Sample vial for alkaline solution (100mL) (10 pcs)
013581	Sample vial for alkaline solution (200mL) (8 pcs)
013582	RRDE-3A Teflon cap (for 200mL)
012632	Sample vial (100mL)
012167	RE-1B Reference electrode (Ag/AgCl)
013613	RE-1BP Reference electrode (Ag/AgCl)
013848	RE-7N Non Aqueous reference electrode (Ag/Ag ⁺)
013597	RHEK Reversible hydrogen electrode kit
012961	Platinum counter electrode 23 cm
013343	O-ring for RRDE-3A Teflon cap V.2
013645	O-ring for RRDE-3A Shaft (white, 3 pcs)
012641	O-ring for RRDE-3A Bearing assembly (10 pcs)

Electrodes and accessories

Disk Electrode & Ring Disk Electrode

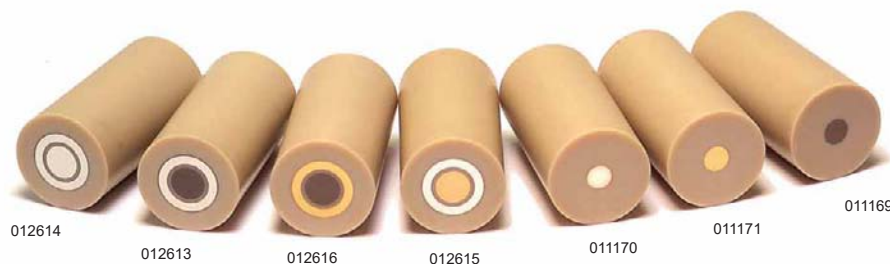

INSPECTED
https://www.als-japan.com/dl/inspection_data_sheet_link

The Ring-Disk and Disk electrodes listed below are working electrodes for RRDE-3A Rotating Ring Disk Electrode Apparatus. Organic solvent resistant resin, PEEK, is used as insulating body material, it can be polished with PK-3 Electrode Polishing kit.

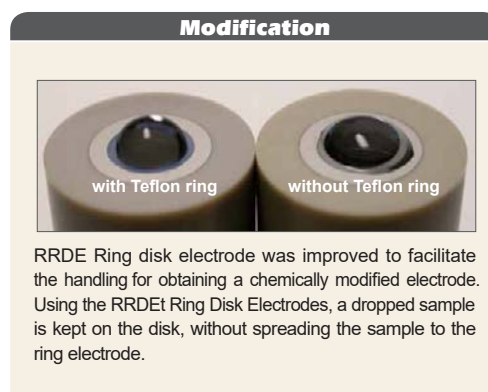
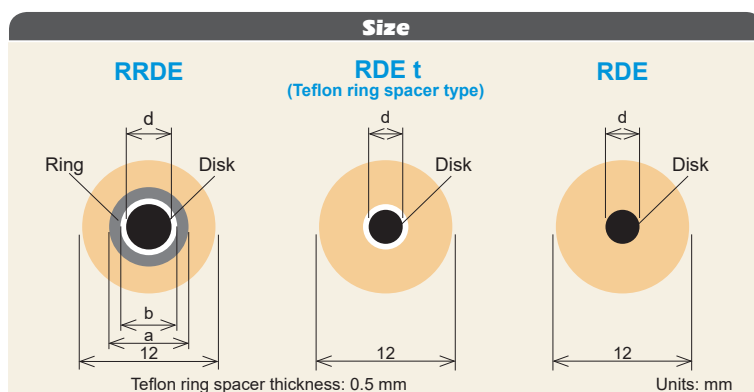

Catalog No.	Description	Electrode size		Isolation OD	Length
		Ring OD(a) / ID(b)	Disk(d)		
Ring disk electrodes					
012613	RRDE Pt ring/GC disk electrode	7 mm / 5 mm	4 mm	12 mm	25 mm
012614	RRDE Pt ring/Pt disk electrode	7 mm / 5 mm	4 mm	12 mm	25 mm
012615	RRDE Pt ring/Au disk electrode	7 mm / 5 mm	4 mm	12 mm	25 mm
012616	RRDE Au ring/GC disk electrode	7 mm / 5 mm	4 mm	12 mm	25 mm
012617	RRDE Au ring/Pt disk electrode	7 mm / 5 mm	4 mm	12 mm	25 mm
012653	RRDE Au ring/Au disk electrode	7 mm / 5 mm	4 mm	12 mm	25 mm
012618	RRDE GC ring/GC disk electrode	7 mm / 5 mm	4 mm	12 mm	25 mm
Disk electrodes					
011169	RDE GCE Glassy carbon disk electrode	-	3 mm	12 mm	25 mm
013490	RDE GCEt Glassy carbon disk electrode ^{*1}	-	3 mm	12 mm	25 mm
013482	RDE GCE Glassy carbon disk electrode	-	5 mm	12 mm	25 mm
013491	RDE GCEt Glassy carbon disk electrode ^{*1}	-	5 mm	12 mm	25 mm
011170	RDE PTE Platinum disk electrode	-	3 mm	12 mm	25 mm
011171	RDE AUE Gold disk electrode	-	3 mm	12 mm	25 mm
011966	RDE ALE Aluminum disk electrode	-	3 mm	12 mm	25 mm
011967	RDE AGE Silver disk electrode	-	3 mm	12 mm	25 mm
011968	RDE CUE Copper disk electrode	-	3 mm	12 mm	25 mm
011969	RDE NIE Nickel disk electrode	-	3 mm	12 mm	25 mm
011970	RDE TAE Tantalum disk electrode	-	3 mm	12 mm	25 mm
011971	RDE TIE Titanium disk electrode	-	3 mm	12 mm	25 mm
011972	RDE WE Tungsten disk electrode	-	3 mm	12 mm	25 mm
011973	RDE CPE Carbon paste disk electrode ^{*2}	-	3 mm	12 mm	25 mm

Note: RDE/RRDE electrodes are designed to be used in RRDE-3A Rotating Ring Disk Electrode Apparatus, we will not guarantee the operation when above RDE/RRDE electrodes are used in combination with RRDE apparatus made by other companies.

*1. Teflon ring spacer type. It is easier to apply a catalyst than using the conventional glassy carbon disk electrodes.

*2. 001010 CPO Carbon paste (1 g) is sold separately (p.11).

DRE Disk Replaceable Electrode



The Disk Replaceable Electrode (DRE) offers a removable disk electrode. The replacement of the disk electrode is possible from both sides, front side and rear side. It enables a selection according to the condition required for your research purpose.

Features

1. Utilization of the same materials for disk and ring electrodes can avoid the influence of the ring material.
2. Removable disk and ring assembly enables the modification of the electrode surface and to do the polishing process separately.
3. Disposable and custom build disks can be used.



ALS support product manual
<https://www.als-japan.com/support-product-manual.html>
Manual download link



INSPECTED
<https://www.als-japan.com/dl/>
Inspection data sheet link

DRE Disk Replaceable Electrode (RRDE)



Catalog No.	Description	
013336	DRE-PGK Pt ring/GC disk replaceable electrode kit	
013641	DRE-GGK GC ring/GC disk replaceable electrode kit	
Contents		
013337	DRE-PTR Pt ring assembly	1
013642	DRE-GCR GC ring assembly	1
013339	DRE-SPC Teflon spacer (3 pcs)	1
013338	DRE-GCD GC disk	1
Optional items		
013366	DRE-AUD Au disk	
013367	DRE-PTD Pt disk	

DRE Disk Replaceable Electrode (RDE)



Catalog No.	Description	
013362	DRE-GCK GC disk replaceable electrode kit	
013364	DRE-AUK Au disk replaceable electrode kit	
013365	DRE-PTK Pt disk replaceable electrode kit	
Contents common for the kits		
013361	DRE-DAS Disk assembly	1
013339	DRE-SPC Teflon spacer (3 pcs)	1
Optional items		
013338	DRE-GCD GC disk	
013366	DRE-AUD Au disk	
013367	DRE-PTD Pt disk	

Note: RDE/RRDE electrodes are designed to be used in RRDE-3A Rotating Ring Disk Electrode Apparatus, we will not guarantee the operation when above RDE/RRDE electrodes are used in combination with RRDE apparatus made by other companies.

DRE-DCP Disk electrode polishing and exchanging tool kit

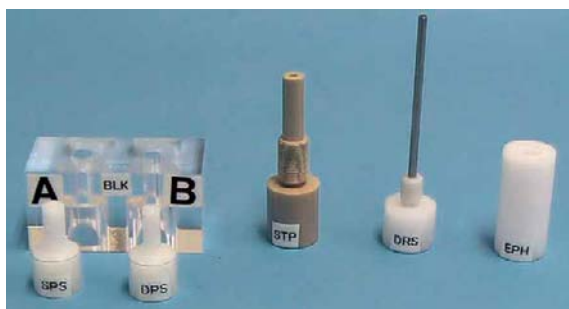

Catalog No.	Description	
013608	DRE-DCP Disk electrode polishing and exchanging tool kit	
Contents		
	DRE-BLK Base block	1
	DRE-STP Stopper	1
	DRE-DRS Disk remove tool	1
	DRE-SPS Spacer push tool	1
	DRE-DPS Disk push tool	1
	DRE-EPH Electrode polishing holder	1

Handling procedure for the DRE

The DRE-STP Stopper is screwed into the DRE-PTR Pt ring assembly. It is used for the adjustment of the height, after the DRE-SPC Teflon spacer and DRE-GCD GC disk are attached. The "A" side of the DRE-BLK Base block is used for the DRE-SPC Teflon spacer attachment, and "B" side is for the DRE-GCD GC disk attachment.

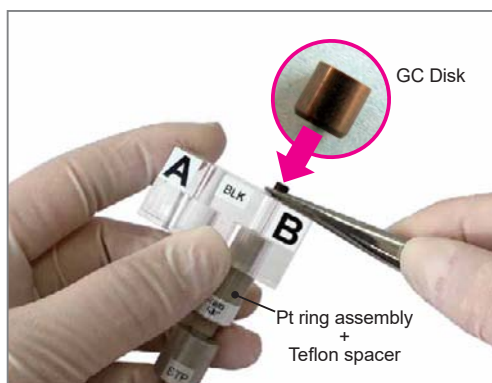

Fig.1

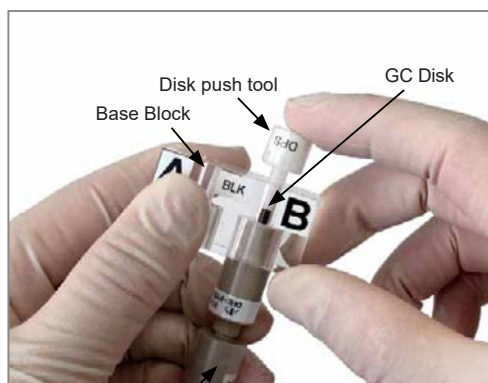

Fig.2



Fig.3

After attaching the DRE-SPC Teflon spacer into the DRE-PTR Pt ring assembly on the "A" side and adjusting the height, move the DRE-PTR Pt ring assembly to the "B" side, to fit the DRE-GCD GC disk from the front side, as shown above.

Put the DRE-GCD GC disk from the front side (Fig. 1) and adjust it with DRE-DPS Disk push tool (Fig. 2).

Take it out from the DRE-BLK Base block and adjust the height with DRE-STP Stopper and DRE-DRS Disk remove tool, until it is flush with the surrounding surface (Fig. 3).



ALS support RRDE

<https://www.als-japan.com/support-rrde.html>

Support Movie link

RRDE Disk replaceable electrode assessment test

The illustration in the section above shows the fitting of the DRE-GCD Glassy carbon disk from the front side. However, for electrodes with modified surfaces it can be assembled from the rear side, see performance test below.

Typical test parameters are:

Working electrode : DRE-RRDE Pt ring GC disk electrode

Reference electrode: Ag/AgCl

Counter electrode : Platinum wire

Test solution : 2 mM potassium ferricyanide/1 M KNO₃

Initial voltage : + 600 mV

Final voltage : - 200 mV

Scan Rate (Volt) : 10 mV/s

Rotation Rate : 100 to 3,000 rpm

Sensitivity : 10⁻⁵ A/V

2nd potential : + 600 mV

Fitting for the front side:

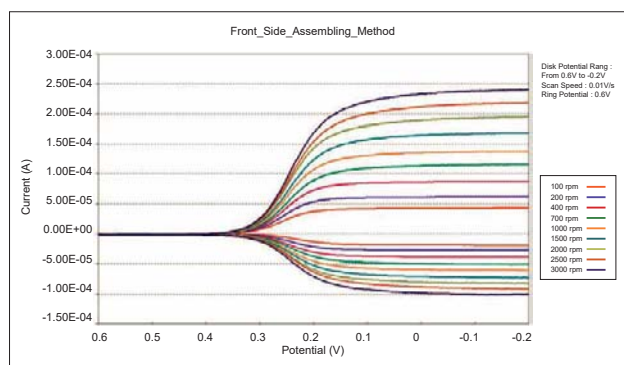

Fitting for the rear side:

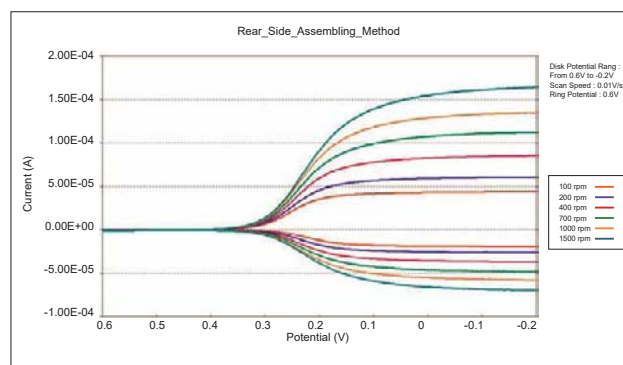

H2G1 Portable Hydrogen Generator



Features

- Electrolysis and fast potential measurement
- Filling time: about 5 min (for 1.2 mol HCl solution)
- Can be used with four AAA batteries

Catalog No.	Description
013699	H2G1 Portable Hydrogen Generator
Specification	
Output current	10 mA \pm 30%
Output Voltage	28 V
Potential measurement range	about 10 - 999 mV
Operating temperature and humidity range	10 - 50 °C \leq 80% RH
Power	four AAA batteries
Size	about 81 (W) x 32 (H) x 141 (D) mm
Weight	about 270 g
Accessories	Cable (red, white, black) 45 cm each

The Portable hydrogen generator H2G1 is used to generate hydrogen by electrolysis in the Reversible Hydrogen Electrode (RHE). The versatile and safe Reversible Hydrogen Electrode (RHE) is ready to be used after hydrogen gas is generated in the RHEK Reversible hydrogen electrode kit. The Reversible Hydrogen Electrode has high accuracy, stability and can be used for checking the potential of other reference electrodes or as an alternative for the traditional standard hydrogen electrode (SHE).

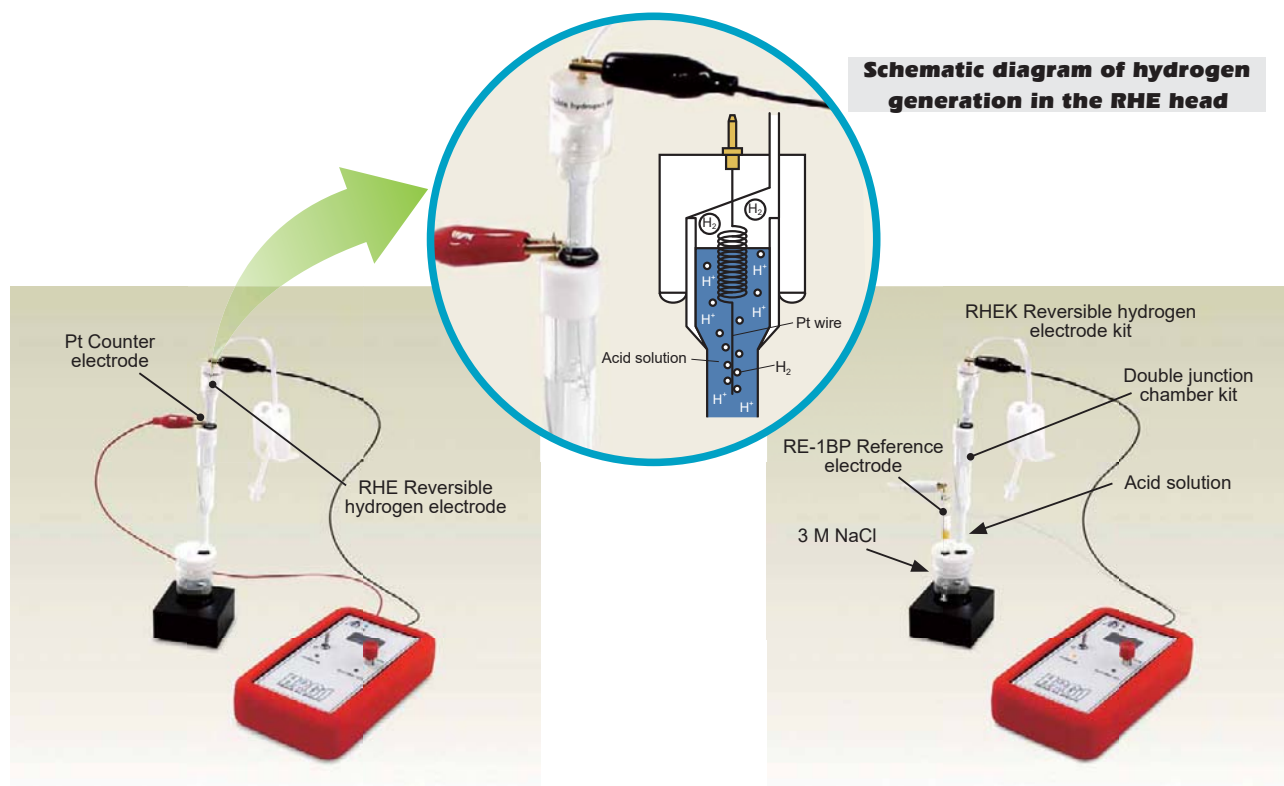

1. Electrolytic hydrogen generation function

2. Potential measurement auxiliary function (*)

* The potential measurement mode is an auxiliary function; for an accurate electrode potential measurement, an appropriate device is recommended. Please note that reference electrodes using an internal solution with lower ion mobility, such as saturated K_2SO_4 solution, may result in higher deviation.

2

Reference Electrodes

Reference electrodes are widely used for electrochemical measurements (CV, LSV, DPV, etc.) and in electrochemical devices (electrochemical detection for HPLC, electrochemical biosensor, etc.). Various kinds of them such as aqueous, non-aqueous, calomel and self-assembled types are available.

Reversible Hydrogen Electrode



001209

001209 Cell holder for 20 mL vial and 012669 SVC-3 Voltammetry cell are sold separately.

RHE is a reversible electrode kit. Hydrogen gas is generated by electrolysis of a strong acid and stored in the electrode. This avoids the complicated and dangerous set-up of the hydrogen cylinder and the exhaust of large volumes of hydrogen gas, even though it provides a good potential stability.

Catalog No.	Description		Qty
013597	RHEK Reversible hydrogen electrode kit		
Contents			
1	013598	RHE Reversible hydrogen electrode	1
2	013378	RHEK accessories kit	1
2a	(Content)	Tubing clamp	1
2b		Silicone tube (10 cm)	3
2c		O-ring	1
2d		Female lure fitting	1
2e		Disposable syringe	1

Catalog No.	Description		Qty
3	013375	Double junction chamber kit	
Contents			
3a	013376	Double junction chamber	1
3b	013377	PTFE Cap for double junction chamber	1
3c	002222	Platinum counter electrode 5.7 cm	1



ALS support product manual
<https://www.als-japan.com/support-product-manual.html>
Manual download link

Contents & Options

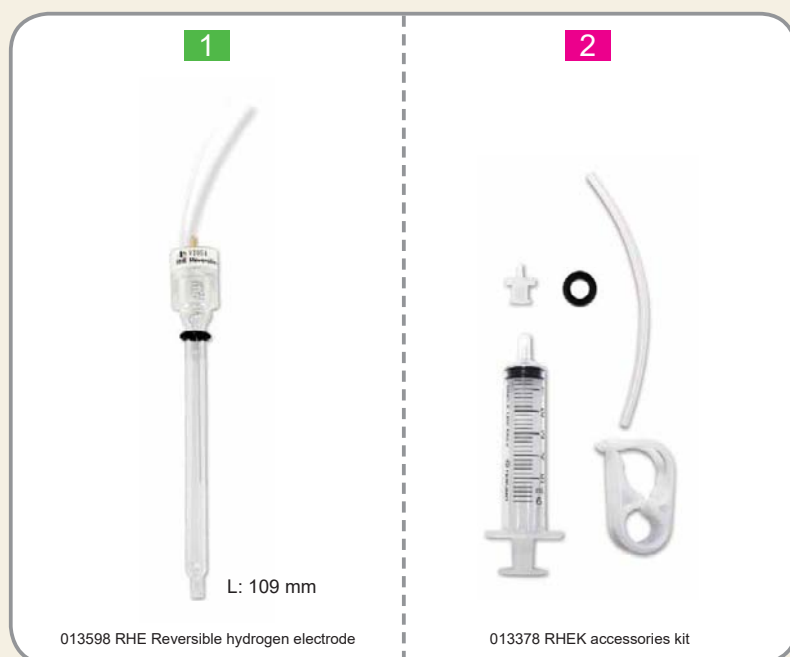

013597 RHEK Reversible hydrogen electrode kit

* "L" is an approximately length

For Aqueous solution

Ag/AgCl type

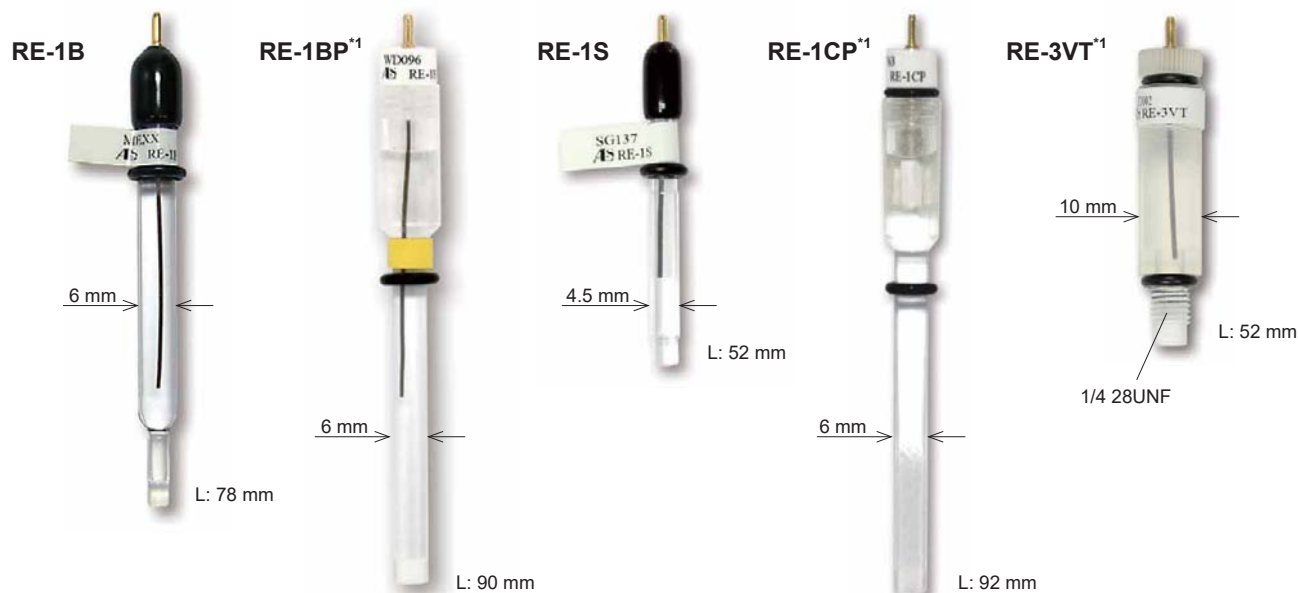

* "L" is an approximately length

RE-1B Reference potential*2

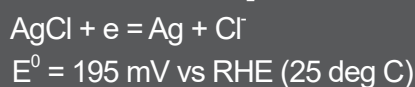

Features

- For applications in aqueous solutions
- Relatively long life time

RE-1BP Reference potential*2

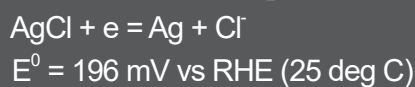

RE-1CP Reference potential*2

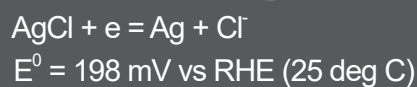

Catalog No.	Description	Junction	Electrolyte	Purpose
012167	RE-1B Reference electrode (Ag/AgCl)	IPPG ³	3 M NaCl	SVC-2, SVC-3, VC-4, Bulk electrolysis, RRDE, EQCM
013613	RE-1BP Reference electrode (Ag/AgCl)	Ceramics	3 M NaCl	SVC-2, SVC-3, VC-4, Bulk electrolysis, RRDE, EQCM
013393	RE-1S Reference electrode (Ag/AgCl)	IPPG ³	3 M NaCl	SECM
013691	RE-1CP Reference electrode (Ag/AgCl/Saturated KCl)	Ceramics	saturated KCl	SVC-2, SVC-3, VC-4, Bulk electrolysis, RRDE, EQCM
013488	RE-3VT Reference electrode screw type (Ag/AgCl)	Ceramics	3 M NaCl	For Flow cell (LC, EQCM, SEC-3F)

*1. Polymethyl pentene

*2. The reference potential mentioned for each reference electrode is the measured value using RHEK reversible hydrogen electrode kit (Cat. No.013597).

*3. IPPG: Ion Permeability Porous Glass



ALS support product manual
<https://www.als-japan.com/support-product-manual.html>
Manual download link



INSPECTED
<https://www.als-japan.com/dl/>
Inspection data sheet link

Reference Electrodes

Hg type

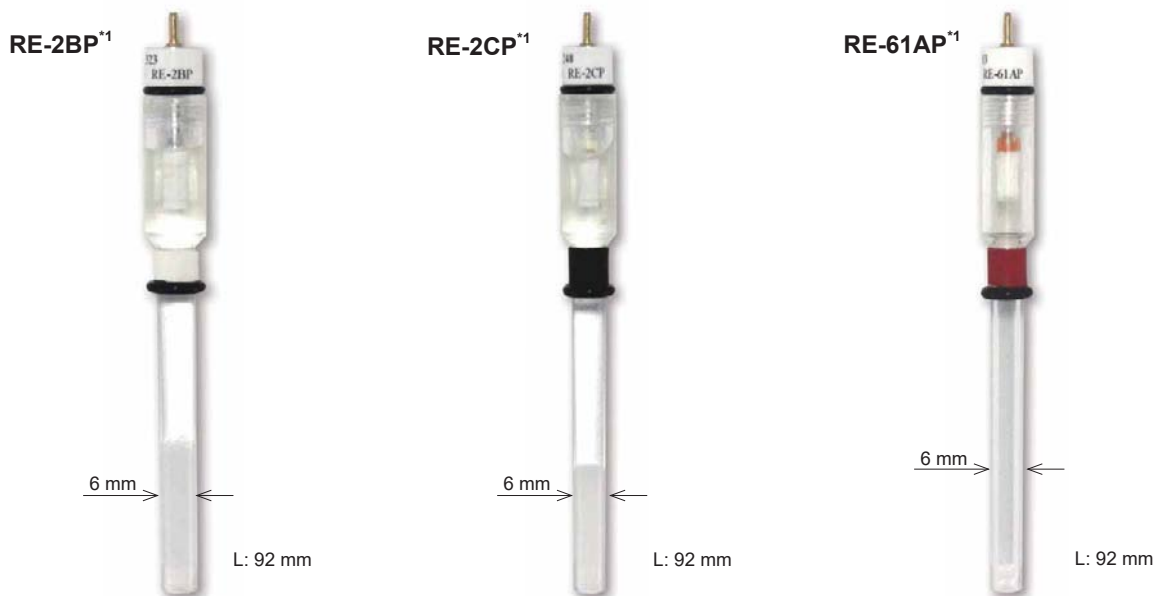

* "L" is an approximately length

RE-2BP Reference potential^{*2}

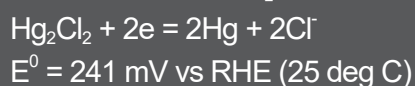

Features

- Internal solution can be replaced

RE-2CP Reference potential^{*2}

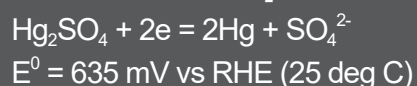

RE-61AP Reference potential^{*2}

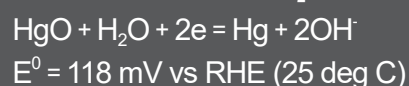

Catalog No.	Description	Junction	Electrolyte	Purpose
013693	RE-2BP Calomel reference electrode	Ceramics	Saturated KCl	For application as a standard reference electrode
013692	RE-2CP Reference electrode	Ceramics	Saturated K ₂ SO ₄	For application as a free from chloride ion measurement
013694	RE-61AP Reference electrode	Ceramics	-	For application in an alkaline solution

*1. Polymethyl pentene

*2. The reference potential mentioned for each reference electrode is the measured value using RHEK reversible hydrogen electrode kit (Cat. No.013597).

The reference electrode can be selected depending on the sample to be measured. The following is a table of recommended pH ranges for the reference electrode line-up.

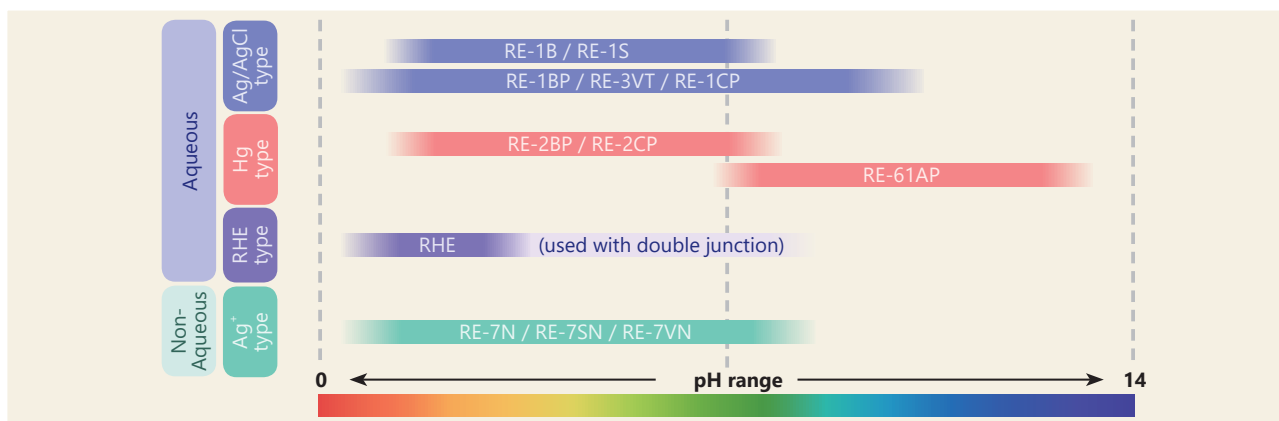

For Non Aqueous solution

Ag/Ag⁺ type

RE-7N



L: 81 mm

RE-7SN



L: 62 mm

RE-7VN^{*1}



L: 52 mm

1/4 28UNF

* "L" is an approximately length

Features

- For applications in organic solvents
- Internal solution can be replaced



ALS support product manual

<https://www.als-japan.com/support-product-manual.html>

Manual download link

Catalog No.	Description	Junction	Electrolyte	Purpose
013848	RE-7N Non Aqueous reference electrode (Ag/Ag ⁺)	IPPG ^{*2}	custom ^{*3}	SVC-2, SVC-3, VC-4, Bulk electrolysis, RRDE, EQCM
013849	RE-7SN Non Aqueous reference electrode (Ag/Ag ⁺)	IPPG ^{*2}	custom ^{*3}	SECM
013850	RE-7VN Non Aqueous reference electrode (Ag/Ag ⁺)	Ceramics	custom ^{*3}	For Flow cells (LC, EQCM, SEC-3F)
Optional items (sold separately)				
012108	RE-PV Preservative vial for reference electrode			For preservation of OD 6.0 mm reference electrodes
012057	RE-7N Teflon cap with Ag wire			For replacement, manufacturing of electrodes
012058	RE-7SN Teflon cap with Ag wire			For replacement, manufacturing of electrodes
012176	Sample holder dia 6mm (2pcs)			For double junction, manufacturing of electrodes

*1. Polymethyl pentene *2. IPPG: Ion Permeability Porous Glass *3. ACN: acetonitrile
TBAP: tetrabutylammonium perchlorate

Technical note

Internal solution preparation

The internal solution of an Ag/Ag⁺ reference electrode used in a non aqueous solvent system consists mainly of a salt containing Ag⁺ ions and a supporting electrolyte added to the same non aqueous solvent as the solution sample to be measured.

As an example, an acetonitrile (ACN) solution containing 0.01 mol/L silver(I) nitrate (AgNO₃) and 0.1 mol/L tetrabutylammonium perchlorate (TBAP) could be used.

NOTES:

- The reagents used for the preparation are not available from our company. Please purchase commercially available high grade reagents separately.
- Please use organic solvents, e.g. acetonitrile that have been dried and dehydrated in advance.
- Make sure to wear protective equipment while working, and be careful when handling chemical substances.
- The amount of solution prepared should be small, so please consider it according to your experimental plan.



ALS instruction for electrolyte preparation

<https://www.als-japan.com/2035.html#defaultTab15>

Sample Holder & Accessories



These products allow to perform electrochemical measurement with only 200 μL sample volume. An IPPG* tip is attached to the end of a glass tube, so ions can transmit freely. The sample holders are multi-purpose accessories.

- 6 mm diameter holders can be used for RE-7N series reference electrodes
- 9 mm diameter can be used in SVC-2 voltammetry cell
- Both can be used as a salt bridge, in which a reference electrode is installed in order to prevent contamination.

Catalog No.	Description
012176	Sample holder dia 6.0 mm (2 pcs)
012306	Sample holder dia 6.0 mm (22 pcs)
012177	Sample holder dia 9.0 mm (2 pcs)
012307	Sample holder dia 9.0 mm (22 pcs)

*IPPG (Ion Permeability Porous Glass) is a porous glass with 40-200 \AA diameter of pores. Chemically stable, operational as high as 800 $^{\circ}\text{C}$. It can be cut with a sharp knife.

Reminder:

Yellowish discoloration indicates contamination. This is caused by the absorption of organics into the pores from air.

Catalog No.	Description
012796	Repair kit for Sample holder*

* Contents: Heat shrink Teflon tubing, 150 mm
IPPG Rod, dia 3.2 x 4.0 mm, 10 pcs

Preservative vial



* Reference electrode is sold separately

If a purchased or self-assembled reference electrode is left in direct contact with air, the solution inside will evaporate and dry up gradually. In order to maintain the performance and life time of a reference electrode, it is recommended to store the electrode in a sealed preservative bottle with a solution similar to the reference electrode internal electrolyte.

For example:

3 M NaCl for the preservation of the RE-1B Reference electrode.

Catalog No.	Description	Qty
012108	RE-PV Preservative vial for reference electrode	
Contents		
011987	Teflon cap for RE-PV	1
-----	Screw vial 10 mL	1

Ag/AgCl Ink for Reference electrode



Reference electrodes can be easily prepared by coating Ag/AgCl ink on a metal (Ag, Pt, Au, etc.) surface. The only requirement is to deposit the Ag/AgCl ink and wait for it to dry. The reference electrode prepared by Ag/AgCl ink is quite useful for IDA electrode measurements.

Catalog No.	Description
011464	Ag/AgCl Ink for reference electrode preparation (2.0 mL)
Specification	
Surface resistance	0.2 $\Omega/\text{sq}/25.4 \mu\text{m}$
Viscosity	50 $\pm 10 \text{ Pa}\cdot\text{s}$ @21.1 deg C
Flash point	82 $^{\circ}\text{C}$

3

Working Electrodes

General Working Electrodes for Voltammetry

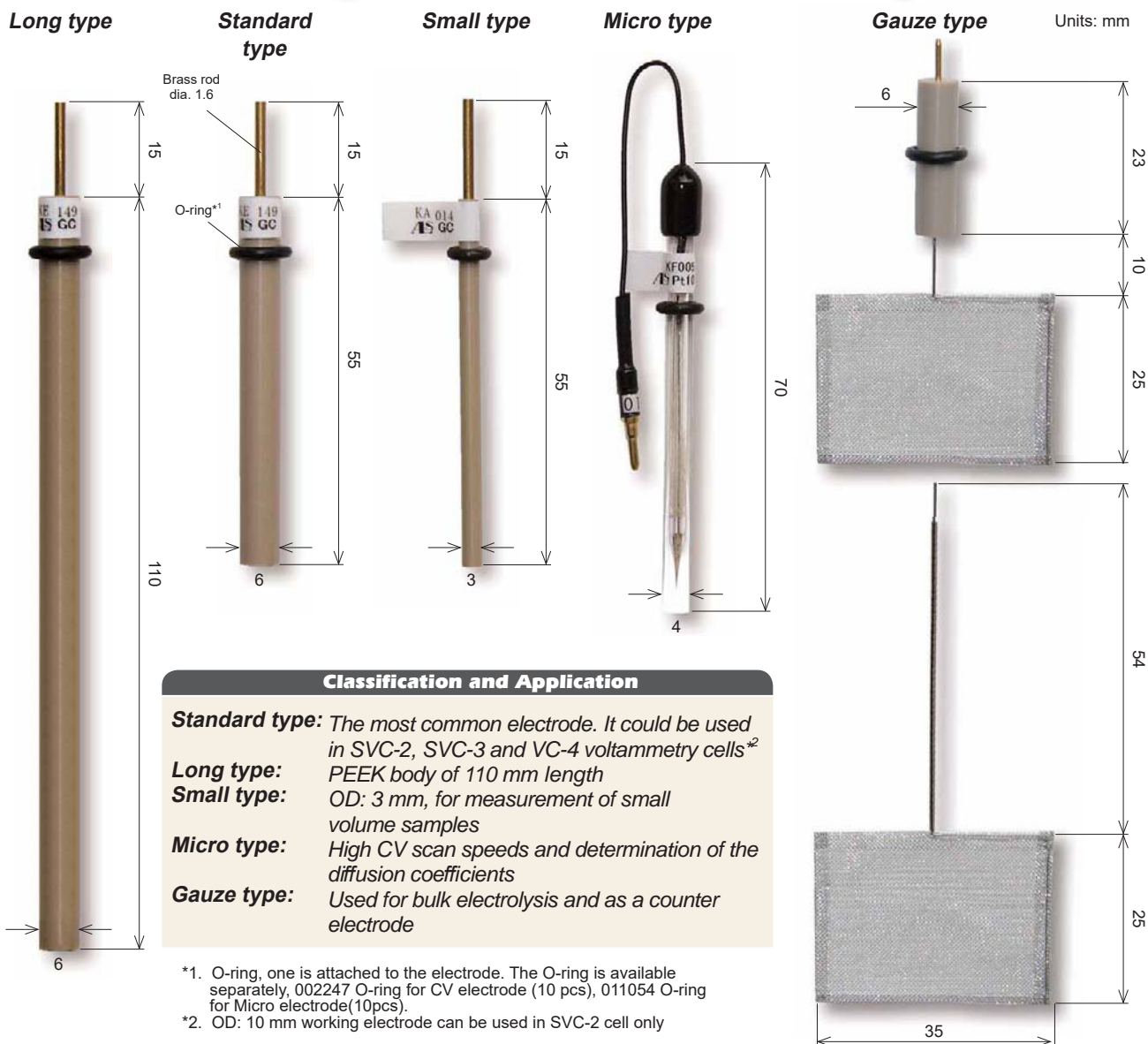

CPO Carbon Paste Oil



Carbon Paste Oil (CPO) is prepared by mixing uniform-sized graphite powder and paraffin oil. The oil is applied to Carbon Paste Electrode to create:

- 1) simple enzyme electrodes
- 2) chemically modified electrodes

It can not be used in organic solvents. Keep the container closed to avoid contamination.

How to prepare carbon paste electrodes:

- 1) Mix and homogenize the compound to be analyzed in the CPO
- 2) Fill mixture tightly into the electrode's hole with a small spatula
- 3) Remove the excess CPO and polish the surface of the electrode with circular movements on a clean paper

Catalog No.	Description
001010	CPO Carbon paste oil base (1 g)

Full Listing of Working Electrodes

Catalog No.	Description	Isolation	Specification	
002250	Platinum gauze electrode	PEEK	80 mesh	35×25 mm
012619	Platinum gauze electrode, lead wire 54 mm	-	80 mesh	35×25 mm
002251	Gold gauze electrode	PEEK	100 mesh	35×25 mm
002417	GCE Glassy carbon electrode	PEEK	OD: 10 mm	ID: 5 mm
013715	GCEt Glassy carbon electrode	PEEK	OD: 10 mm	ID: 5 mm
012744	LGCE Glassy carbon electrode	PEEK	OD: 6 mm	ID: 3 mm
013714	GCEt Glassy carbon electrode	PEEK	OD: 6 mm	ID: 3 mm
002012	GCE Glassy carbon electrode	PEEK	OD: 6 mm	ID: 3 mm
012297	GCE Glassy carbon electrode	PEEK	OD: 6 mm	ID: 1.6 mm
002411	GCE Glassy carbon electrode	PEEK	OD: 6 mm	ID: 1 mm
012298	SGCE Glassy carbon electrode	PEEK	OD: 3 mm	ID: 1.6 mm
002412	SGCE Glassy carbon electrode	PEEK	OD: 3 mm	ID: 1 mm
002002	MCE Micro Carbon fiber electrode	Glass	OD: 4 mm	ID: 33 μm
002007	MCE Micro Carbon fiber electrode	Glass	OD: 4 mm	ID: 7 μm
002418	AUE Gold electrode	PEEK	OD: 10 mm	ID: 5 mm
012746	LAUE Gold electrode	PEEK	OD: 6 mm	ID: 3 mm
002421	AUE Gold electrode	PEEK	OD: 6 mm	ID: 3 mm
002014	AUE Gold electrode	PEEK	OD: 6 mm	ID: 1.6 mm
002314	SAUE Gold electrode	PEEK	OD: 3 mm	ID: 1.6 mm
002010	MAUE Micro Gold electrode	Glass	OD: 4 mm	ID: 100 μm
002004	MAUE Micro Gold electrode	Glass	OD: 4 mm	ID: 25 μm
002006	MAUE Micro Gold electrode	Glass	OD: 4 mm	ID: 10 μm
002420	PTE Platinum electrode	PEEK	OD: 10 mm	ID: 5 mm
012745	LPTE Platinum electrode	PEEK	OD: 6 mm	ID: 3 mm
002422	PTE Platinum electrode	PEEK	OD: 6 mm	ID: 3 mm
002013	PTE Platinum electrode	PEEK	OD: 6 mm	ID: 1.6 mm
002313	SPTE Platinum electrode	PEEK	OD: 3 mm	ID: 1.6 mm
002009	MPTE Micro Platinum electrode	Glass	OD: 4 mm	ID: 100 μm
002003	MPTE Micro Platinum electrode	Glass	OD: 4 mm	ID: 25 μm
002005	MPTE Micro Platinum electrode	Glass	OD: 4 mm	ID: 10 μm
002416	AGE Silver electrode	PEEK	OD: 10 mm	ID: 5 mm
002419	AGE Silver electrode	PEEK	OD: 6 mm	ID: 3 mm
002011	AGE Silver electrode	PEEK	OD: 6 mm	ID: 1.6 mm
002315	SAGE Silver electrode	PEEK	OD: 3 mm	ID: 1.6 mm
002016	NIE Nickel electrode	PEEK	OD: 6 mm	ID: 1.5 mm
002273	MNIE Micro Nickel electrode	Glass	OD: 4 mm	ID: 100 μm
002252	PGBE Pyrolytic graphite electrode (Basal Plane)	PEEK	OD: 6 mm	ID: 3 mm
002253	PGEE Pyrolytic graphite electrode (Edge Plane)	PEEK	OD: 6 mm	ID: 3 mm
002408	PFCE 3 Carbon electrode *1	PEEK	OD: 6 mm	ID: 3 mm
002409	PFCE 1 Carbon electrode *1	PEEK	OD: 6 mm	ID: 1 mm
011854	SPFCE 1 Carbon electrode *1	PEEK	OD: 3 mm	ID: 1 mm
002019	PDE Palladium electrode	PEEK	OD: 6 mm	ID: 1.6 mm
002319	SPDE Palladium electrode	PEEK	OD: 3 mm	ID: 1.6 mm
012585	FEE Iron electrode	PEEK	OD: 6 mm	ID: 3 mm
002018	FEE Iron electrode	PEEK	OD: 6 mm	ID: 1.5 mm
012584	CUE Copper electrode	PEEK	OD: 6 mm	ID: 3 mm
002017	CUE Copper electrode	PEEK	OD: 6 mm	ID: 1.6 mm
002210	CPE Carbon paste electrode *2	PEEK	OD: 6 mm	ID: 3 mm
002223	SCPE Carbon paste electrode *2	PEEK	OD: 3 mm	ID: 1.6 mm

Customized electrodes are available on request

*1. Plastic Formed Carbon Electrode (PFCE) is produced in a collaboration of MITSUBISHI PENCIL CO., LTD and National Institute of Advanced Industrial Science and Technology (AIST).

*2. 001010 CPO Carbon paste oil base (1 g) is sold separately (p. 11).



ALS support product manual
<https://www.als-japan.com/support-product-manual.html>
Manual download link



INSPECTED
<https://www.als-japan.com/dl/>
Inspection data sheet link

Lithography / Glass substrate Electrodes

Ring-Disk electrode

This ring-disk type electrodes, developed by NTT-AT, are printed electrodes. Users can choose Carbon, Gold and Platinum as working electrodes. If used for radial flow cells, a complete reduction/oxidation on the center disk can be achieved at micro flow rate because of its good coulometric electrolysis efficiency. This also enables the analysis of subsequent reactions as well as simultaneous identification and quantification of samples. Furthermore, using immobilized Osmium Gel / Horse Radish Peroxidase (HRP), this electrode can measure hydrogen peroxide at zero volt (developed by Prof. Adam Heller, Texas Univ.). Thus this Printed electrode is used in FIA (Flow Injection Analysis) system with combinations of various enzymes.

Catalog No.	Description	Qty
002081	Gold ring disk electrode	3
002082	Platinum ring disk electrode	3
002083	Carbon ring disk electrode	3



Size: 12.5 x 22 x 0.5 mm

Conductivity electrode

Platinum terminals are deposited on a fused quartz substrate as current supplying electrodes and potential difference probing electrodes. The distance between electrodes for potential measurements can be chosen from 40 μm to 250 μm by changing the connection terminals.

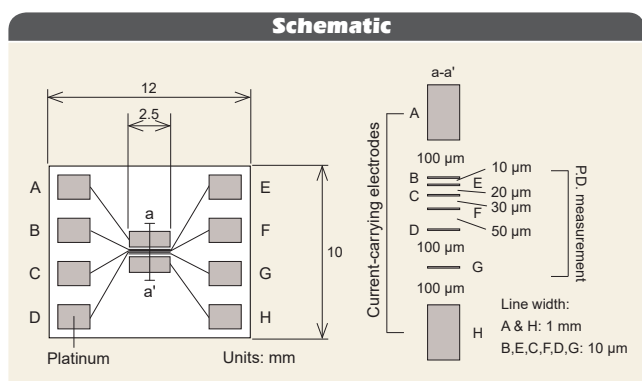
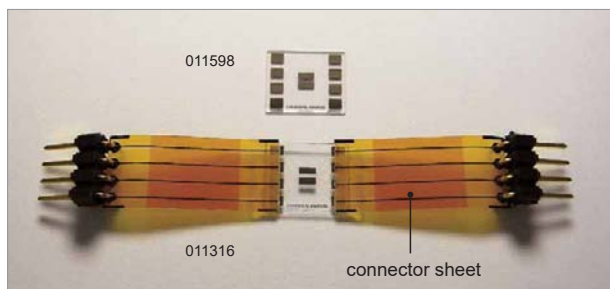

Intervals

Point	Units: μm					
	B	C	D	E	F	G
B		40	140	10	80	250
C	40		90	20	30	200
D	140	90		120	50	100
E	10	20	120		60	230
F	80	30	50	60		160
G	250	200	100	230	160	

Catalog No.	Description	Specification
011316	Conductivity electrode	With connector sheet*
011598	Conductivity electrode (3 pcs)	Without connector sheet

*The connectors listed below are convenient for connection of the electrode with the connector sheet.

- 011839 Connector for printed electrodes
- 011840 IC clip for printed electrodes (4 pcs)

IDA electrodes

Interdigitated Array electrodes (IDA) are electrodes developed for electrochemical measurements to be performed with a very small quantity of a sample. IDA electrodes can be used for the detection and reaction analysis of compounds. The IDA electrode itself is a microelectrode pattern fabricated by using lithography technology. The electrode array consists of 65 pairs, each one of these pairs work as oxidation and reduction electrodes.

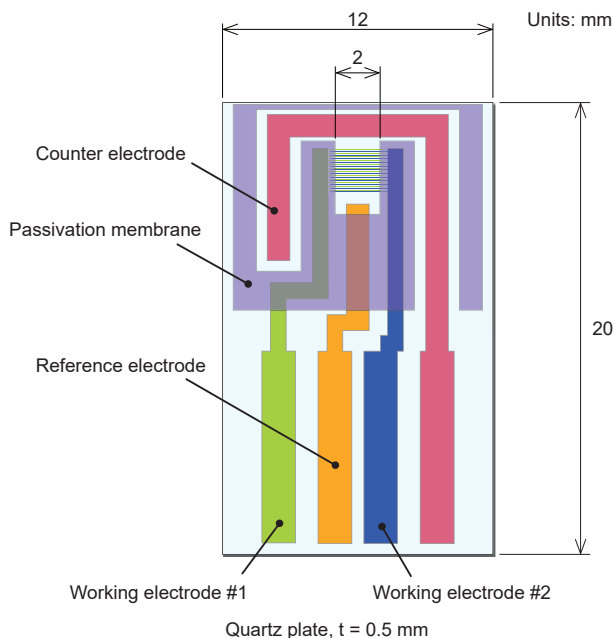

Features

- High sensitive CV measurements
- Electrochemical measurements in a small quantity of a sample
- Small integration size
- High-speed response

Applications

- Electrochemical measurements
- Conductivity measurements
- Biosensors / chemical sensors
- Chemically modified electrodes
- Chemical reaction process control



ALS support product manual

<https://www.als-japan.com/support-product-manual.html>

Manual download link

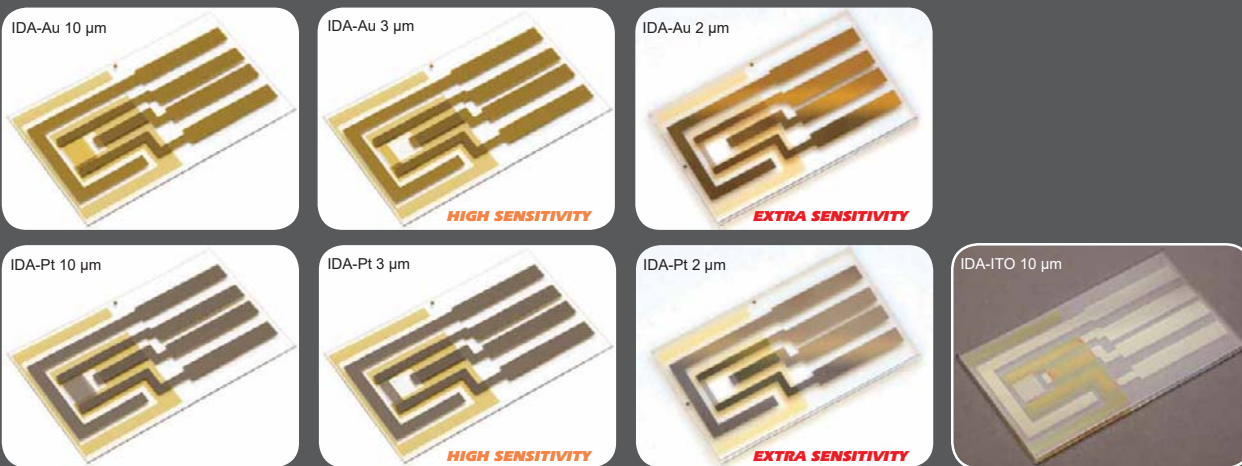

Catalog No.	Description	Qty	Specification				
			Width (μm)	Interval (μm)	Length (mm)	pairs	Film thickness
012125	IDA electrode (Au) 10 μm	1	10	5	2	65	90 nm*
012126	IDA electrode (Pt) 10 μm	1	10	5	2	65	90 nm*
012128	IDA electrode (ITO) 10 μm	1	10	5	2	65	100 ± 20 nm
012129	IDA electrode (Au) 3 μm	1	3	3	2	65	90 nm*
012130	IDA electrode (Pt) 3 μm	1	3	3	2	65	90 nm*
012257	IDA electrode (Au) 2 μm	1	2	2	2	65	90 nm*
012258	IDA electrode (Pt) 2 μm	1	2	2	2	65	90 nm*
011066	Cable kit for IDA electrode	1					
011464	Ag/AgCl Ink for reference electrode (2.0 mL)	1					

* For Au and Pt, the thickness of the Titanium adhesive layer is about 10 nm, resulting in a total thickness of 100 nm.

IDA electrode w/o passivation membrane

There is a method for the calculation of the dielectric constant upon measuring the capacitance by detecting the current during the application of an alternating potential (AC) to the IDA electrode. However, for an IDA electrode with a passivation membrane, the capacitance of the membrane is measured as well, making it impossible to obtain the exact value. For this purpose, IDA electrodes without a passivation membrane were added to the product line-up.

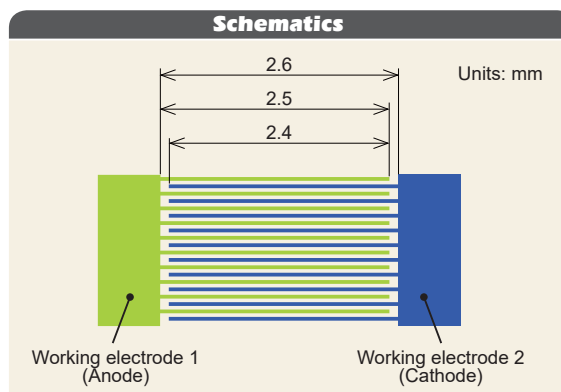

Catalog No.	Description	Qty	Specifications				
			Width (μm)	Interval (μm)	Length (mm)	pairs	Film thickness
012259	IDA electrode (Au) 10 μm without passivation membrane	1	10	5	2.5	65	90 nm*
012262	IDA electrode (Pt) 10 μm without passivation membrane	1	10	5	2.5	65	90 nm*
012266**	IDA electrode (C) 10 μm without passivation membrane	1	10	5	2.5	65	1.2 ± 0.1 μm
012265	IDA electrode (ITO) 10 μm without passivation membrane	1	10	5	2.5	65	100 ± 20 nm
012260	IDA electrode (Au) 3 μm without passivation membrane	1	3	3	2.5	65	90 nm*
012263	IDA electrode (Pt) 3 μm without passivation membrane	1	3	3	2.5	65	90 nm*
012261	IDA electrode (Au) 2 μm without passivation membrane	1	2	2	2.5	65	90 nm*
012264	IDA electrode (Pt) 2 μm without passivation membrane	1	2	2	2.5	65	90 nm*

* For Au and Pt, the thickness of the Titanium adhesive layer is about 10 nm, resulting in a total thickness of 100 nm. ** to be discontinued after stock is sold

Cable kit for IDA electrode

The cable kit is the most suitable connector for IDA electrodes. Be careful when you are inserting or removing the IDA electrode, it consists of quartz glass and it can break easily.

- 1) Put the IDA electrode into the connector
- 2) Insert the **teflon fixer** into the connector



ALS IDA cable kit movie
<https://www.als-japan.com/1681.html>
Support Movie link

Catalog No.	Description	Qty
011066	Cable kit for IDA electrode	
Contents		
012970	Electrode Fixer (Teflon plate)	1
	Mini vice	1
	Connecting cable	1

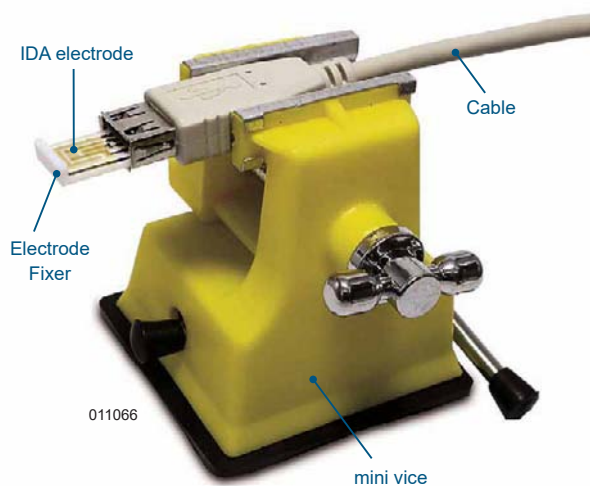

4

Counter Electrodes

Four different shapes of the counter electrodes are available. Select the counter electrodes suitable for the experimental conditions. Custom-made counter electrode is also available.

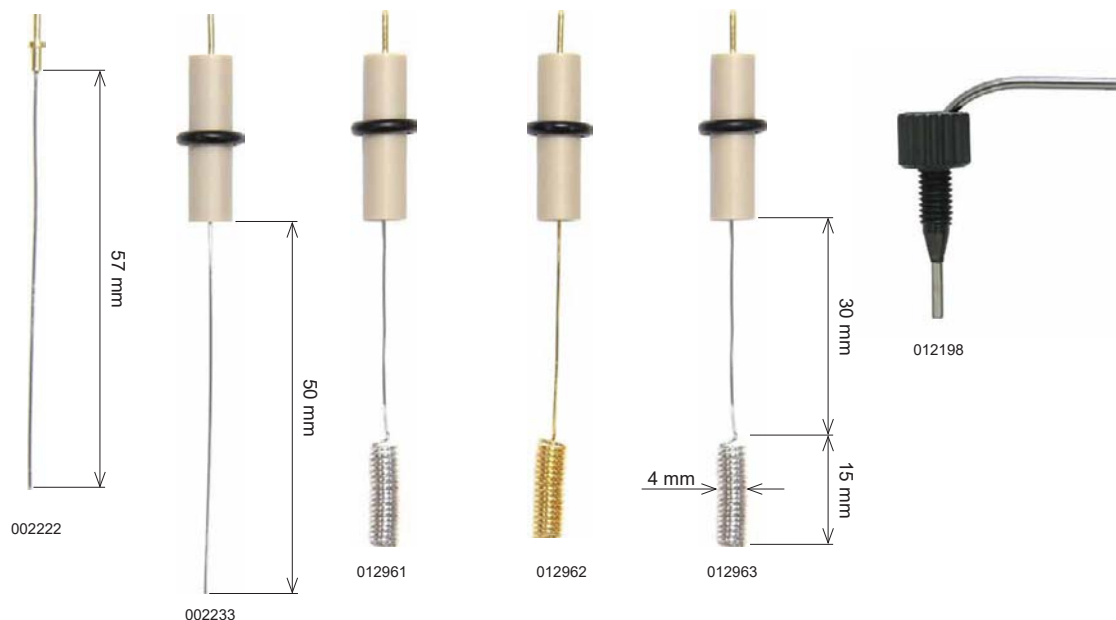

Catalog No.	Description	Purpose
002222	Platinum counter electrode 5.7 cm	SVC-2, VC-4, Plate Material Evaluating cell
002233	Platinum counter electrode 5 cm	SVC-3
012961	Platinum counter electrode 23 cm	RRDE, Bulk electrolysis, SVC-3
012962	Gold counter electrode 23 cm	RRDE, Bulk electrolysis, SVC-3
012963	Nickel counter electrode 23 cm	RRDE, Bulk electrolysis, SVC-3
012198	Counter electrode for Flow cell	Stainless steel pipe, for Flow cell (LC, EQCM, SEC-3F)

Technical note

The role of Counter electrode

For a system using a three-electrode potentiostat, current is measured while a requested potential is adjusted between working electrode and reference electrode. The current flow through an electrical circuit requires an electron transfer process between working electrode and counter electrode. The main function of the counter electrode is to provide a location for the second electron transfer reaction. The surface area is an important parameter of a counter electrode. It should be large enough to support the current generated for the working electrode. For example, the surface area of a Platinum electrode of 5 cm in length is sufficient for using it for steady-state cyclic voltammetry experiments. However, for performing high current measurements such as bulk electrolysis, a counter electrode with a larger area is required, such as Catalog No.012961 with a length of Platinum of 23 cm. This electrode can also be used for experiments with a rotating ring disk setup.

The cell shape is important as well. For electrolysis, the counter electrode is placed in a separate chamber isolated from the working electrode to avoid contamination of the product with reaction products generated at the counter electrode. For electrochemical measurements like cyclic voltammetry, the effects of contamination can be ignored because of the short measurement times. Therefore, the counter electrode usually is not isolated. In some cases, the separation of the counter electrode in a chamber increases the resistance between counter electrode and reference electrode, due to the sintered glass frit. However, in the case of bulk electrolysis, because of long measurement times, the agitation and the separation of the working electrode and counter electrode using a chamber is recommended, to prevent the transfer of substances between the two electrodes.

5

Voltammetry Cells

SVC-2 Voltammetry cell

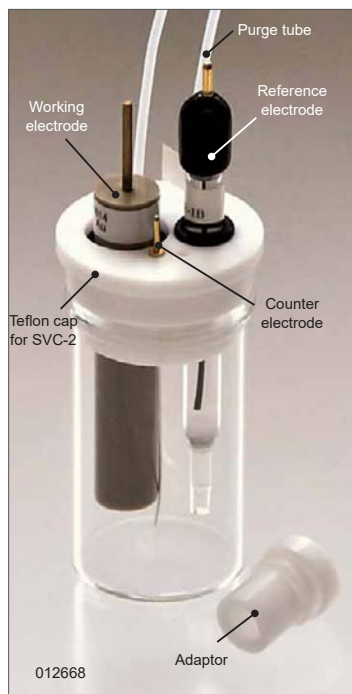

Working electrodes and reference electrodes are sold separately. Each component can be purchased separately. If purchased separately, the 20 mL sample vials are shipped in a quantity of 10 pieces.

Multi purpose cell - 4 operation modes

SVC-2 Voltammetry cell can be used in 4 different configurations. It can be operated as an oxygen-free voltammetry cell. Using a sample holder with 9.0 mm in diameter, it allows to use very small sample volumes (100 - 200 μ L).

Features and location of holes in the Teflon cap

- For various types of electrodes
- Sample volume from 5 to 10 mL
(For very small volumes from 100 to 200 μ L*)
- Easy removal of dissolved oxygen

A : for OD 9, 10 mm electrode
B : for OD 4, 6 mm electrode
Adaptor : for OD 6 mm electrode

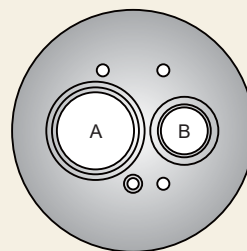

* 012177 Sample holder dia 9 mm is sold separately.

Catalog No.	Description	Qty
012668	SVC-2 Voltammetry cell	
Contents		Qty
(001056)	Sample vial (20 mL)	7
002222	Platinum counter electrode 5.7 cm	1
012670	Teflon cap for SVC-2	1
(010537)	Purge tube (ETFE), 30 cm	1
Optional item		
012177	Sample holder dia 9.0 mm (2 pcs)	

4 operation modes

Standard

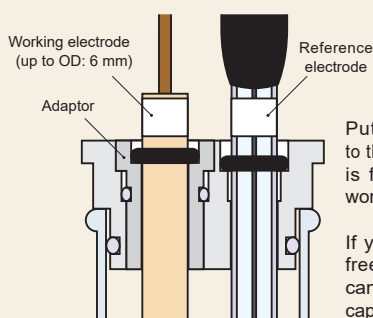

Put the Teflon cap adaptor in to the Teflon cap. The cap adaptor is fixed with a silicon O-ring to work in oxygen-free conditions.

If you do not need the oxygen-free condition, the silicon O-ring can be taken out from the Teflon cap.

10 mm WE

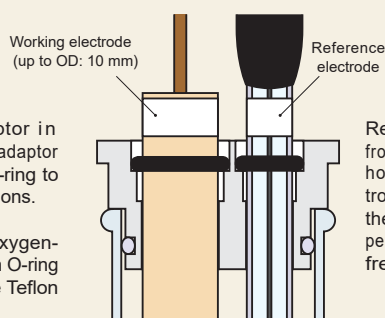

Remove the Teflon cap adaptor from the Teflon cap. 9 mm sample holder and 10mm working electrodes can be fitted directly in to the Teflon cap. The O-ring will fit perfectly. It permits to have oxygen-free condition in the cell.

Small sample

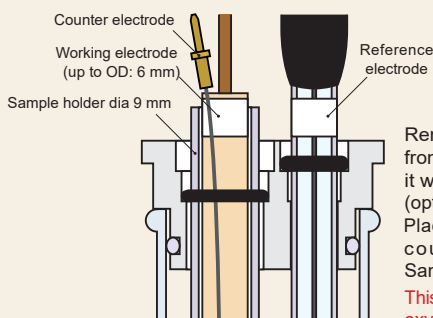

Remove the Teflon cap adaptor from the Teflon cap, and replace it with a 9.0 mm Sample holder (optional item). Place the working electrode and counter electrode into the Sample holder.

This configuration does not provide oxygen free conditions.

Low temperature

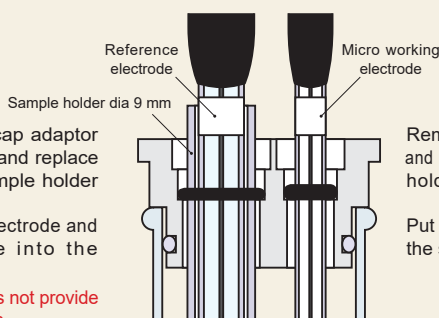

Remove the Teflon cap adaptor, and replace it by a 9.0 mm Sample holder (optional item).

Put the reference electrode into the sample holder.

SVC-3 Voltammetry cell

Standard voltammetry cell



012669

- Sample volume from 5 to 10 mL
- For various types of electrodes
- Easy removal of the dissolved oxygen

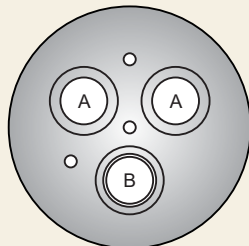

A : for OD 6 mm electrode
B : for OD 4, 6 mm electrode

Reference electrode is sold separately.

Catalog No.	Description
012669	SVC-3 Voltammetry cell
Contents	
(001056)	Sample vial (20 mL)
002223	Platinum counter electrode 5 cm
012671	Teflon cap for SVC-3
(010537)	Purge tube (ETFE), 30 cm
Optional items	
012961	Platinum counter electrode 23 cm
012963	Nickel counter electrode 23 cm

Plate Material Evaluating cell

Evaluation of plate materials



011951

This quite handy cell was developed in order to evaluate plate materials such as metals, semi-conducting plates, etc.

Reference electrode is sold separately.

Catalog No.	Description
011951	Plate Material Evaluating Cell
Contents	
	Teflon Cell [Body]
	Teflon Cell [Base]
	Teflon cap
	O-ring (Viton)
	Screw 20 mm
002222	Platinum counter electrode 5.7 cm
(010537)	Purge tube (ETFE), 30 cm

VC-4 Voltammetry cell

Small sample measurement cell



011224

- Sample volume from 1 to 3 mL
- Including cell holder
- Uses standard 6 mm electrodes

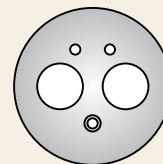

Reference electrode is sold separately.

Catalog No.	Description
011224	VC-4 Voltammetry cell
Contents	
(011504)	Sample vial (5 mL)
002222	Platinum counter electrode 5.7 cm
011226	Teflon cap for VC-4
011227	Cell holder for 5 mL vial
(010537)	Purge tube (ETFE), 30 cm

Bulk Electrolysis cell

High current complete electrolysis



013647

Bulk electrolysis cell is used for complete electrolysis of a solution. Typical applications are quantification of mass transfer of electrons per molecule, measurement of absolute quantity of the analyte, and electrochemical synthesis of materials (generally in quantities of milligrams).

Reference electrode is sold separately.

Catalog No.	Description
013647	SBC Bulk electrolysis cell
Contents	
012632	Sample vial (100 mL)
012961	Platinum counter electrode 23 cm
013648	Teflon cap for SBC
013616	PCE Porous carbon electrode
001198	Lid for counter electrode
001196	Chamber for counter electrode
001236	O-ring for counter electrode
009131	Port plug
000178	Stirrer bar
(010537)	Purge tube (ETFE), 30 cm
Optional item	
013580	Sample vial for alkaline solution (100 mL) (10 pcs)
012652	Water-Jacketed glass cell (100 mL)

Cell Vials



• Tolerance of each dimension is approximately ± 0.5 mm. • The inner diameter (ID) is the size at the top side.

Catalog No.	Description	Vol (mL)	OD (mm)	ID (mm)	Height (mm)	Qty	Purpose
011504	Sample vial ^{*1}	5	18	15.6	30	10	VC-4
001056	Sample vial ^{*1}	20	28	25.6	50	10	SVC-2, SVC-3
012632	Sample vial ^{*1}	100	50	46.4	72	1	RRDE-3A, Bulk Electrolysis Cell
013580	Sample vial for alkaline solution ^{*2}	100	51.5	46.5	72	10	RRDE-3A, Bulk Electrolysis Cell
013581	Sample vial for alkaline solution ^{*2}	200	67	62	72	8	RRDE-3A, Bulk Electrolysis Cell
012672	Water-Jacketed glass cell	5	40	15.6	40	1	VC-4
001051	Water-Jacketed glass cell	20	55	25.6	50	1	SVC-2, SVC-3
012652	Water-Jacketed glass cell	100	70	46.4	80	1	RRDE-3A, Bulk Electrolysis Cell
013596	Teflon cap for CV (100mL)					1	For 012632, 012652, 013580
013582	RRDE-3A Teflon cap (for 200 mL)					1	For 013581
001209	Cell holder for 20 mL vial					1	SVC-2, SVC-3

*1 Hard glass for scientific research *2 Polymethyl pentene

6

Flow Cells

Electrochemical Flow Cells

Our working electrodes for flow cells are embedded in blocks of PEEK. This resin protects the electrodes from external noise and allows researchers to utilize the cell regardless of the content of mobile phase of HPLC due to its hardness and organic solvent resistance. Glassy carbon electrodes are usually chosen for redox reaction studies in liquid chromatography. Platinum, Gold, Carbon paste, and Nickel electrodes are utilized for special purposes.

Working electrodes for Flow cell



Features

- Excellent chemical resistance
- Easy maintenance of the working electrode
- Working electrode can be polished with PK-3 Polishing kit

Catalog No.	Description	Size	Purpose	
Dual	001000	Glassy carbon electrode (Dual 3 mm)	25 × 25 mm	For CF, general redox measurements
	001002	Gold electrode (Dual 3 mm)	25 × 25 mm	For CF, measurement of thiol-related compounds
	001012	Platinum electrode (Dual 3 mm)	25 × 25 mm	For CF, measurement of hydrogen peroxide & oxidized substances
	001008	Silver electrode (Dual 3 mm)	25 × 25 mm	For CF, measurement of cyano-sulfide
	001009	Nickel electrode (Dual 3 mm)	25 × 25 mm	For CF, amino acids measurement by chemically modified electrode
	001004	Carbon paste electrode (Dual 3 mm)*	25 × 25 mm	For CF, modified electrode measurement using carbon paste
	001006	Glassy carbon / Gold electrode	25 × 25 mm	For CF, others
	012583	Glassy carbon / Platinum electrode	25 × 25 mm	For CF, others
Single	012124	Glassy carbon electrode (Single 3 mm)	25 × 25 mm	For RF, general redox measurements
	001016	Glassy carbon electrode (Single 6 mm)	25 × 25 mm	For RF, general redox measurements
	000999	PFCE Carbon electrode (Single 3 mm)	25 × 25 mm	For RF, general redox measurements
	011155	Gold electrode (Single 3 mm)	25 × 25 mm	For RF, measurement of thiol-related compounds
	009908	Platinum electrode (Single 3 mm)	25 × 25 mm	For RF, measurement of hydrogen peroxide and oxidized substances
	010251	Carbon paste electrode (Single 3 mm)*	25 × 25 mm	For RF, modified electrode measurement using carbon paste

*001010 CPO Carbon paste oil based (1 g) is sold separately (p.11).

CF: Cross Flow cell RF: Radial Flow cell

Structure of the working electrode

The dual glassy carbon electrode is considered as standard working electrode for the cross flow cell. It is composed of two 3 mm glassy carbon electrodes placed in series. It can be rotated 90 degrees and be used in parallel mode. The selectivity improves if a dual series electrode is used. In parallel mode, identification of substances at different applied voltage response ratios is possible.

For the dual electrode, the electrode surface area doubles by using the jumper connector and high sensitivity analysis becomes possible. As working electrode materials, Platinum, Gold, and other materials are available.

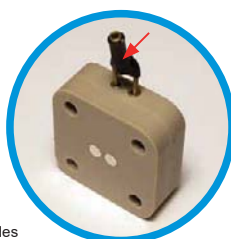

002245 Jumper connector for dual electrodes

single/radial flow

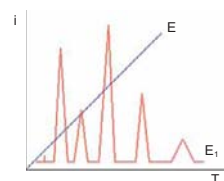
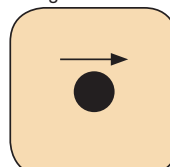

dual, series/cross flow

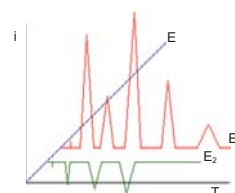
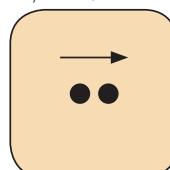

dual, parallel/cross flow

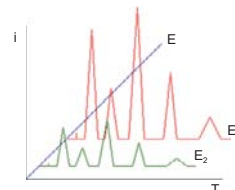
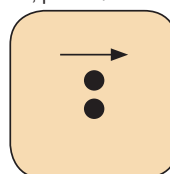

Cross Flow Cell

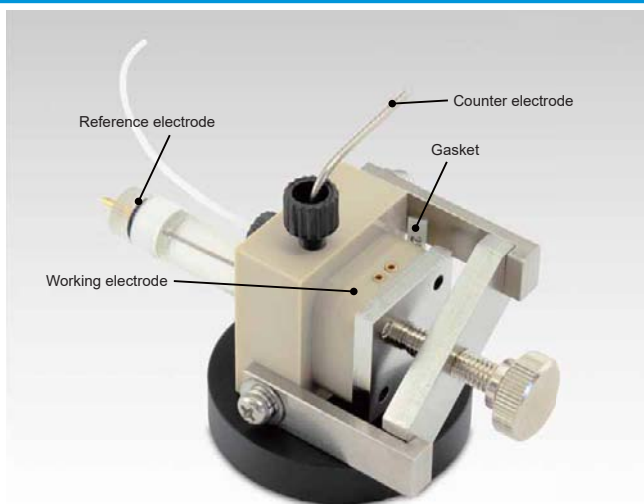

The Cross Flow Cell is capable to measure concentrations down to 10^{-15} mol/L using flow rates of 1 mL - 100 μ L/min.

Features

- Detection electrode for HPLC
- Used for Flow injection analysis
- Used for bio-sensor development

Schematic diagram of Cross flow cell

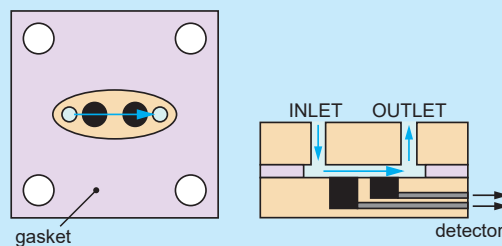

* Working electrode, reference electrode and Gaskets are sold separately.

Catalog No.	Description
012798	Cross Flow cell

Radial Flow Cell

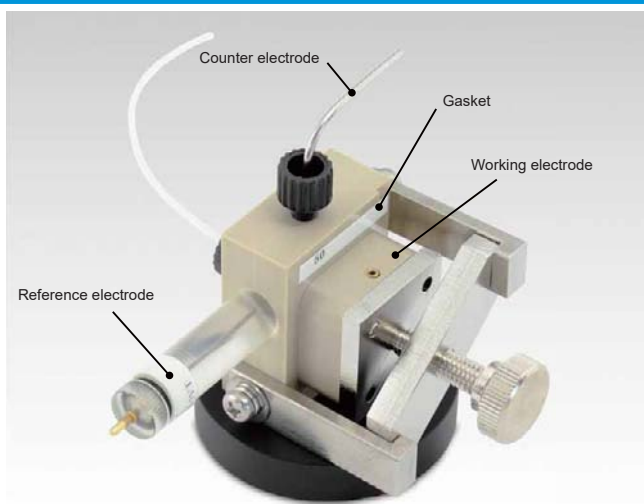

Radial Flow Cell was developed for microbore chromatography. Its detecting efficiency will improve when flow rates are 10 μ L/min or lower. This flow cell consists of a thin layer electrode and a symmetric design.

The wall-jet of analyte hits the surface of electrode, spreads in this layer from the center to the perimeter of the electrode, resulting in enhanced detection sensitivity.

Schematic diagram of Radial flow cell

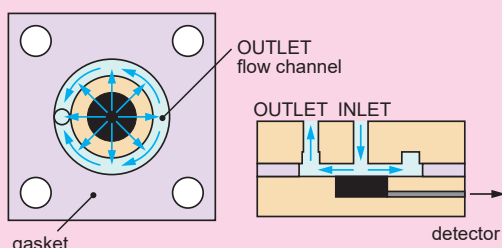

Catalog No.	Description
012799	Radial Flow cell

* Working electrode, Reference electrode and Gaskets are sold separately.

Optional items

Catalog No.	Description
013488	RE-3VT Reference electrode screw type (Ag/AgCl)
013850	RE-7VN Non Aqueous reference electrode screw type (Ag/Ag ⁺)
001046	TG-2M Teflon Gasket (Cross Flow) / 12 μ m (4 pcs)
001047	TG-5M Teflon Gasket (Cross Flow) / 25 μ m (4 pcs)
001048	TG-6M Teflon Gasket (Cross Flow) / 50 μ m (4 pcs)
012801	TG-8M Teflon Gasket (Cross Flow) / 100 μ m (4 pcs)
001146	TG-2MR Teflon Gasket (Radial Flow) / 12 μ m (4 pcs)
001147	TG-5MR Teflon Gasket (Radial Flow) / 25 μ m (4 pcs)
001148	TG-6MR Teflon Gasket (Radial Flow) / 50 μ m (4 pcs)
012802	TG-8MR Teflon Gasket (Radial Flow) / 100 μ m (4 pcs)
002245	Jumper connector for dual electrodes
012912	0.04" Single lead connector (2 pcs)

QCM Flow Cell

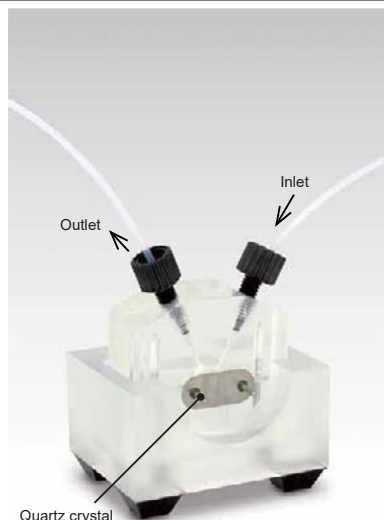

QCM Flow cell mode

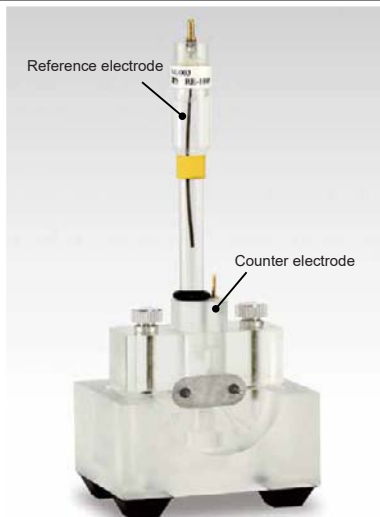

EQCM mode

Contents of QCMT Flow cell

Flow cell; Batch cell; Cap; Flow cell holder; Pt counter electrode; PEEK Fittings; Fixing screws; Silicon O-ring; Teflon tube

The quartz crystal microbalance (QCM) technique, or coupling electrochemistry and crystal oscillation (eQCM), are very useful to determine compounds such as metal proteins, metal ions and thiol-conjugated oligonucleotides. The resonance frequency of the quartz crystal changes when material attaches to the electrode's surface. Using this unique behavior, these cells allow sub-micro grams quantitative analysis. For the best performance, degassed samples to avoid bubbles should be used and temperature needs to stay constant. The QCMT Flow cell can be used in two ways; by turning the blocks, it is possible to change from static mode to flow mode measurements.

Catalog No.	Description
013486	QCMT Flow cell kit
Optional items	
013610	Quartz crystal Au (5 pcs)
013447	Quartz crystal Pt (3 pcs)
012772	Blank Crystal with holder (5 pcs)
012167	RE-1B Reference electrode (Ag/AgCl)
013613	RE-1BP Reference electrode (Ag/AgCl)
013848	RE-7N Non Aqueous reference electrode (Ag/Ag ⁺)

Quartz crystal

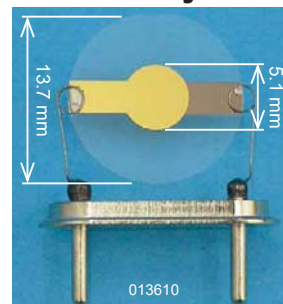

Frequency: 7.995 MHz



ALS support product manual
<https://www.als-japan.com/support-product-manual.html>
Manual download link

EQCM Flow Cell

Combination of QCM and electrochemical measurements in a flow cell.

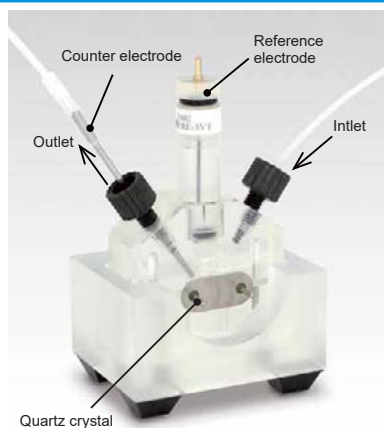

Contents of EQCMT Flow cell

Flow cell; Batch cell; Cap; Flow cell holder; Pt counter electrode; Stainless tube (Counter electrode for flow cell); PEEK Fittings; Fixing screws; Silicon O-ring; Teflon tube

The two blocks of the EQCMT Flow cell are made from Polymethyl pentene. It is highly resistant to chemical compounds.

As well as the QCMT cell, this cell can be used in two ways. By turning the blocks over, it is possible to change from flow mode to static measurements.

Catalog No.	Description
013487	EQCMT Flow cell kit
Optional items	
013610	Quartz crystal Au (5 pcs)
013447	Quartz crystal Pt (3 pcs)
012772	Blank Crystal with holder (5 pcs)
013488	RE-3VT Reference electrode screw type (Ag/AgCl)
013850	RE-7VN Non Aqueous reference electrode screw type (Ag/Ag ⁺)



ALS support product manual
<https://www.als-japan.com/support-product-manual.html>
Manual download link

7

Spectroelectrochemistry

The aim of Spectroelectrochemistry (SEC) is the investigation of electrochemical reaction mechanisms and of the interface between electrolyte solution and the electrode. Remarkable progress in this field and related technologies enable SEC to be applied in wide areas. Nowadays, the relation between absorbance and potential for reversible or quasi-reversible systems is theoretically explicable. On this basis it is possible to analyze electrochemical characteristics of a system, which would be difficult based on a voltammogram only. A typical example is the redox enzyme cytochrome c and methylene blue.

Applications

- Real-time monitoring of chromatic changes during a redox reaction
- Analysis of the charge transfer at the electrode / liquid interface
- Spectrometric measurements near or at the surface of electrodes
- Absorption spectra of products and intermediates
- Parameters: concentrations, diffusion coefficients, and life times

Spectroelectrochemical Batch System

SEC-C Thin Layer Quartz Glass Spectroelectrochemical cell kit

Fittings

SEC-C Thin Layer Quartz Glass Spectroelectrochemical cell kit uses Platinum or Gold mesh electrodes as working electrodes. We offer 0.5 and 1.0 mm optical path length cells. Depending on the spectrometer used, the activity area for the cell is up to 6 mm in diameter with a center at 15 mm above of the bottom. The RE-1B, RE-1BP or RE-7N are recommended to be used as reference electrodes.

Features

- Two varieties of optical path length cells (0.5 and 1.0 mm)
- Designed to be used with 6.0 mm reference electrodes
- Two varieties of working electrodes (Au or Pt)
- Can be used in standard spectrometers

Set up

SEC-C Thin Layer Quartz Glass Spectroelectrochemical cell Kit

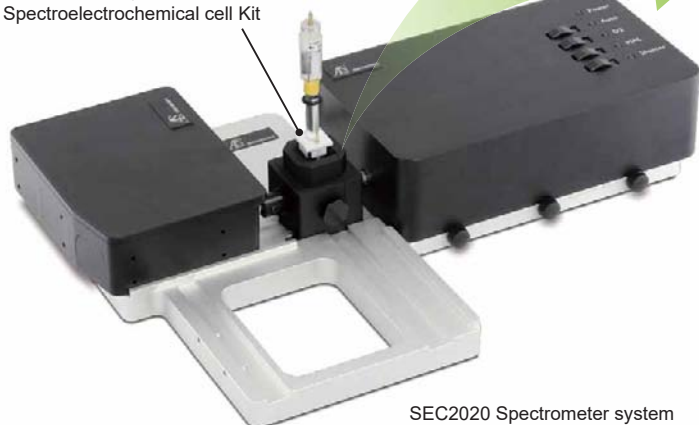

SEC2020 Spectrometer system



ALS Spectroelectrochemical setup

<https://www.als-japan.com/1239.html>

Setup introduction link

1.0 mm Optical path length cell

Types of working electrodes

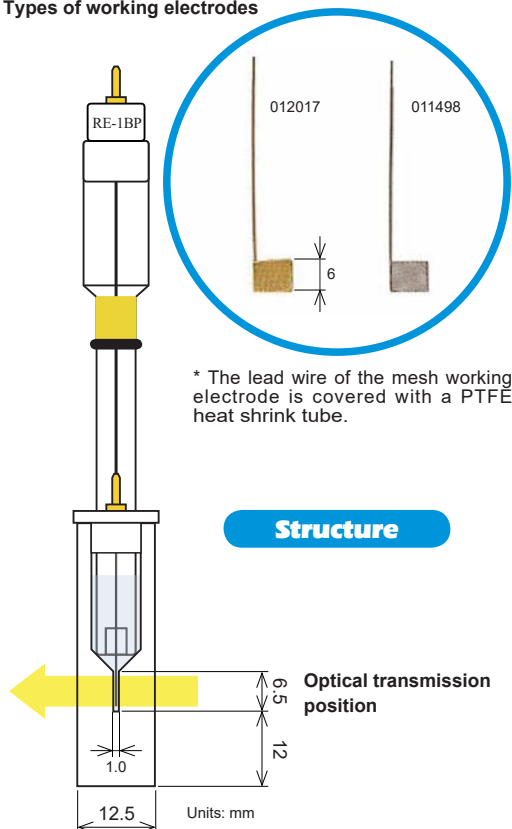

* The lead wire of the mesh working electrode is covered with a PTFE heat shrink tube.

Structure

Optical transmission position

1.0 mm optical path length cell

The 1.0 mm optical path length is suitable for most of the basic spectro-electrochemical measurements. Theoretically, it is possible to get the same result as with 0.5 mm cell using a sample with half of the concentration.



ALS support product manual
<https://www.als-japan.com/support-product-manual.html>
Manual download link

Catalog No.	Description	
013716	SEC-C Thin Layer Quartz Glass Spectroelectrochemical cell Kit (Pt)	
013517	SEC-C Thin Layer Quartz Glass Spectroelectrochemical cell Kit (Au)	
Contents		
013703	SEC-C/C05 Pt counter electrode	
013718	SEC-C Thin Layer Quartz Glass cell	
011501	SEC-C Teflon cap	
(010537)	Purge tube (ETFE) 10 cm	
Working Electrodes		
011498	SEC-C Pt Gauze working electrode*	for 013510
012017	SEC-C Au Gauze working electrode*	for 013511
Optional items		
012167	RE-1B Reference electrode (Ag/AgCl)	
013613	RE-1BP Reference electrode (Ag/AgCl)	
013848	RE-7N Non Aqueous reference electrode (Ag/Ag ⁺)	

0.5 mm Optical path length cell

Types of working electrodes

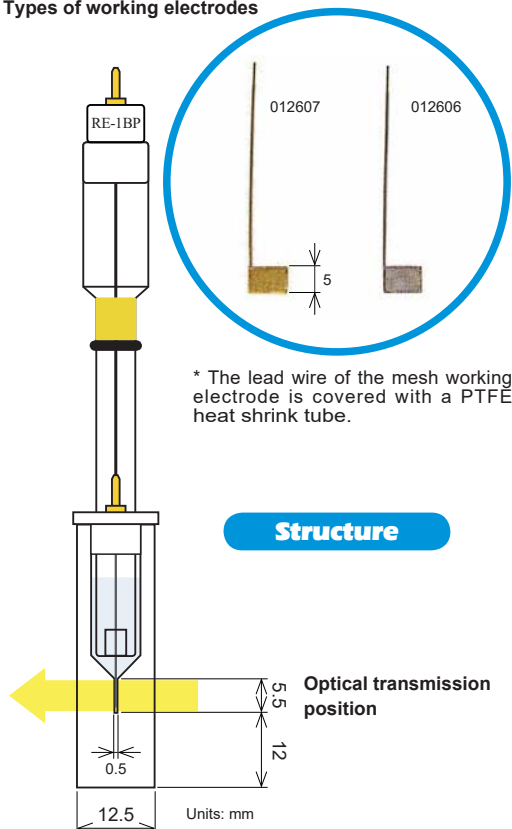

* The lead wire of the mesh working electrode is covered with a PTFE heat shrink tube.

Structure

Optical transmission position

0.5 mm optical path length cell

The 0.5 mm optical path length has a faster equilibration time than the 1.0 mm cell. The shorter time until stability is reached, makes it possible to achieve stable results for measurements in the high volatile organic solvents and allows the detection of unstable electrolysis products.



ALS support product manual
<https://www.als-japan.com/support-product-manual.html>
Manual download link

Catalog No.	Description	
013700	SEC-C05 Thin Layer Quartz Glass Spectroelectrochemical cell Kit (Pt)	
013701	SEC-C05 Thin Layer Quartz Glass Spectroelectrochemical cell Kit (Au)	
Contents		
013703	SEC-C/C05 Pt counter electrode	
013702	SEC-C05 Thin Layer Quartz Glass cell	
011501	SEC-C Teflon cap	
(010537)	Purge tube (ETFE) 10 cm	
Working Electrodes		
012606	SEC-C05 Pt Gauze working electrode*	for 013700
012607	SEC-C05 Au Gauze working electrode*	for 013701
Optional items		
012167	RE-1B Reference electrode (Ag/AgCl)	
013613	RE-1BP Reference electrode (Ag/AgCl)	
013848	RE-7N Non Aqueous reference electrode (Ag/Ag ⁺)	

* There is a specific working electrode for 0.5 mm optical path length cell. The working electrode for the 1.0 mm cell can not be used in 0.5 mm optical path length cell.

SEC2020 Spectrometer system

Wide wavelength range spectrometer



Spectrometer schematic



1. SMA905 connector
2. Slit
3. Collimating mirror
4. Grating
5. Focussing mirror
6. 2048 element CCD array

The SEC 2020 spectrometer is a system that allows various types of spectrometric measurements, focussing on spectro-electrochemical absorption spectroscopy measurements. The high-performance grating and the optical design enables measuring with high sensitivity in a wide wavelength range, from ultraviolet to near infrared (UV/VIS/NIR), with a single unit.

The light source uses a compact modularized combination of a deuterium and a Tungsten halogen lamp. The light source is fixed to the cell holder on the accessory platform for the measurement.

Furthermore, the spectrometer and the light source come with SMA905 connectors, which allow to connect various types of optical fibers, probes and accessories.

Features

- Wide wavelength range: UV/VIS/NIR
- High sensitivity, resolution, and quality
- Deuterium / Tungsten halogen light source
- Measuring platform and analysis software included
- SMA 905 connection terminal
- Dedicated storage box

Applications

- Spectro-electrochemical measurements
- Analysis of solution properties
- Film thickness/composition
- Fluorescence detection*
- Environmental (water and soil) analysis

* For fluorescence detection a high intensity source, such as LED sources is required.

Catalog No.	Description	
013609	SEC2020 Spectrometer system	
Specification		
Spectrometer	Description	SEC2021-025-DUVN
	Detector	2048 element linear silicon CCD array
	Wavelength range	200 - 1025 nm
	Grating	Blaze wavelength (300 nm)
	Slit	25 μ m
	Wavelength resolution	1.3 nm
	Fiber connector	SMA905 Core diameter: 600 μ m NA=0.22
	Interface	USB 2.0
Light source	Operating system	Windows™ 7 / 8.1 / 10, 32/64 bit
	Size (W x D x H)	86 x 110 x 32 mm
	Description	SEC2022
	Light type	Deuterium / Tungsten halogen light source
	Wavelength range	200 - 1700 nm
	Stability	< 0.1 %
	Drift	< 0.25 %/h
	Bulb life	> 1000 h (D2 lamp) > 2000 h (tungsten halogen lamp)
Fiber connector	SMA905	
Size (W x D x H)	100 x 165 x 46 mm	
Cuvette holder description	SEC2023	
Platform description	SEC2024	
Software	SpectraSmart	



Spectroelectrochemical Flow System

SEC-3F Spectroelectrochemical flow cell

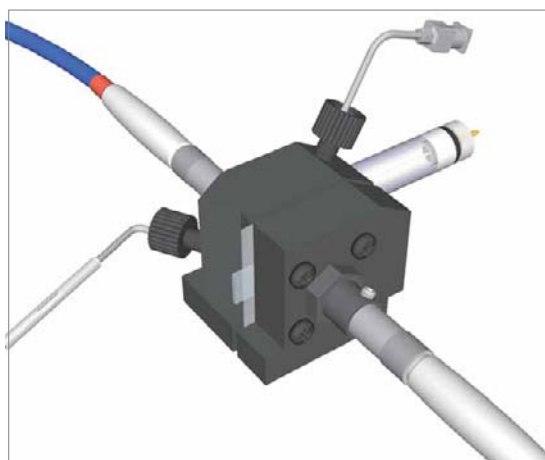

Features

- Thin-layer cell measurement
- Variety of working electrodes
- Can be connected to a variety of optical fiber type spectrometers



ALS SEC movie
<https://www.als-japan.com/support-sec.html>
Support Movie link

Catalog No.	Description
013684	SEC-3F Spectroelectrochemical flow cell NEW

Using different gaskets, the spectroelectrochemical flow cell can be set up to different optical path lengths. We offer, as optional items, Silicon and Teflon gaskets with a 100, 250 and 500 μm of thickness. Other than with the SEC-C Thin Layer Quartz Glass Spectroelectrochemical cell kit, flow injection analysis or stopped flow analysis is possible with this thin layer cell.

The SEC-3F can be connected to a variety of optical fiber type spectrometers by using collimating lenses. Depending on the research topic you can select the working and reference electrodes. As working electrodes, we offer: ITO, Platinum, Gold, or Carbon grid electrodes. As reference electrodes RE-3VT Reference electrode screw type (Ag/AgCl) and RE-7VN Non Aqueous reference electrode screw type (Ag/Ag⁺) can be used.

Configuration

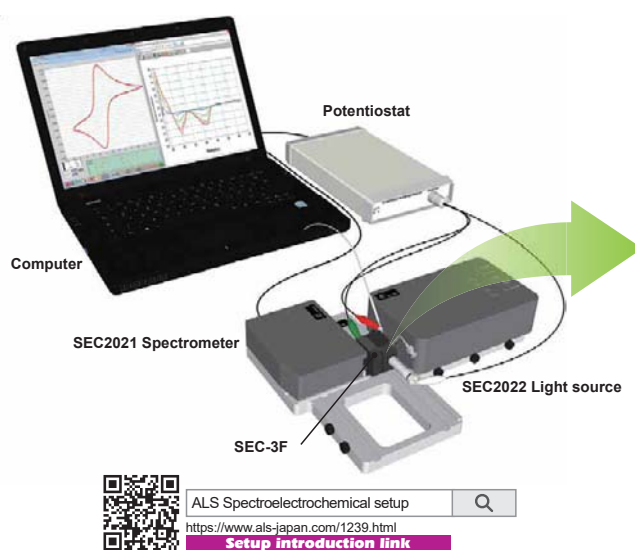

ALS Spectroelectrochemical setup
<https://www.als-japan.com/1239.html>
Setup introduction link

Schematic of Spectroelectrochemical flow cell

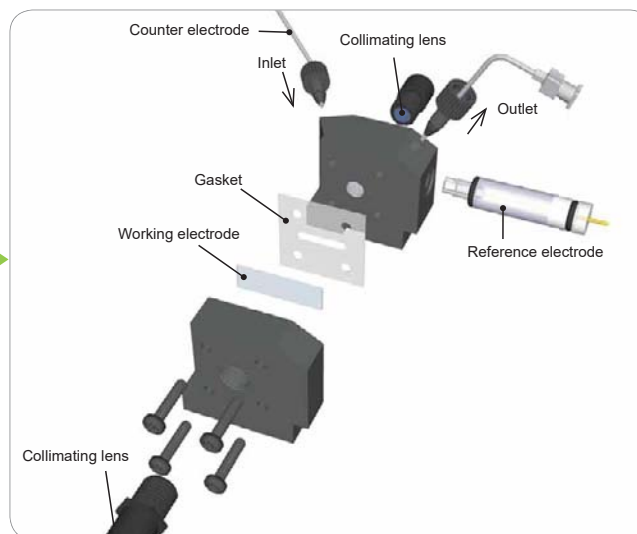

Optional items

1) Gaskets

Catalog No.	Description	Thickness
012661	SEC-2F/3F S500 Silicone Gasket (4 pcs)	500 μm
012664	SEC-2F/3F T500 Teflon Gasket (4 pcs)	500 μm
012665	SEC-2F/3F T250 Teflon Gasket (4 pcs)	250 μm
012666	SEC-2F/3F T100 Teflon Gasket (4 pcs)	100 μm

2) The full list of the working electrodes are shown on the next page.

3) Reference electrodes

Catalog No.	Description
013488	RE-3VT Reference electrode screw type (Ag/AgCl)
013850	RE-7VN Non Aqueous reference electrode screw type (Ag/Ag ⁺)

4) Optical fibers

Catalog No.	Description
012667	SEC-2F/3F 400 μm Optical Fiber SR (25 cm)
012685	SEC-2F/3F 400 μm Optical Fiber SR (2 m)
013688	UV/VIS Collimating Lens, 200-2000 nm

Comparison of the absorbance for different gasket thicknesses

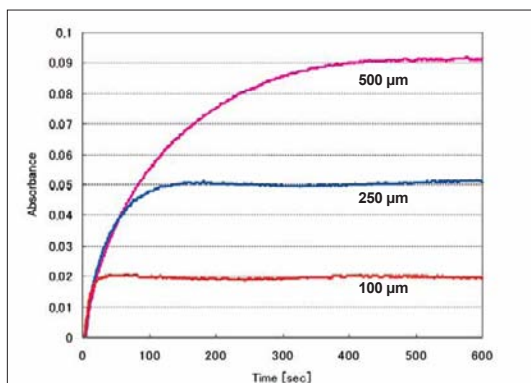

Fig.4-1. Equilibrium time using different gasket thicknesses.

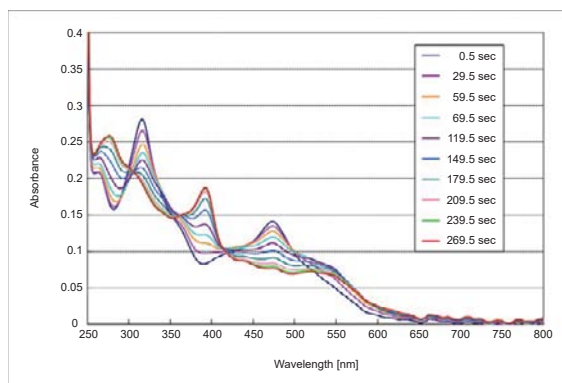

Fig.4-2. Electrolysis spectra of Vitamin B₁₂ derivative complex.

The absorbance at 420 nm of the electrolysis of the potassium ferrocyanide as a function of time, was measured using gaskets with 100, 250 and 500 μm thickness. Using the 100 μm gasket, the equilibrium was achieved in 40 seconds (Figure 4-1). The 250 μm gasket was used for the monitoring of the electrolysis spectrum of the vitamin B₁₂ derivative complex (Figure 4-2).

Spectroelectrochemical Electrodes

ITO Optically transparent electrodes

ITO (Indium Tin Oxide) electrodes are very often used for spectroelectrochemical measurements. ITO electrodes transmit light in the visible range, but block the light in ultraviolet range. The thickness of the ITO layer is 100 ± 10 nm, and the surface resistivity is $15 \pm 1.5 \Omega/\text{sq}^1$.

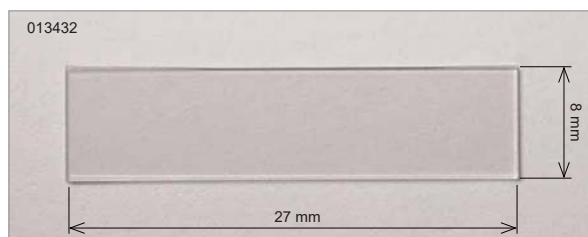

*1. Manufacturer guaranteed value.

*2. Custom-made ITO electrodes are available on request.

Catalog No.	Description
013432	ITO11 electrode 8 x 27 x 1.1 mm (10 pcs)
013435	ITO05 electrode 8 x 27 x 0.5 mm (10 pcs)
Others*2	
013433	ITO11 electrode 10 x 10 x 1.1 mm (10 pcs)
013434	ITO11 electrode 10 x 20 x 1.1 mm (10 pcs)
013436	ITO05 electrode 10 x 10 x 0.5 mm (10 pcs)
013437	ITO05 electrode 10 x 20 x 0.5 mm (10 pcs)

Grid Electrodes

Grid electrodes are produced by deposition of Platinum, Gold, or Carbon onto quartz glass. The dimensions of the glass are 8 x 27 mm, with 1 mm thickness, and the grid lines are 100 μm in width with a distance of 150 μm between lines.

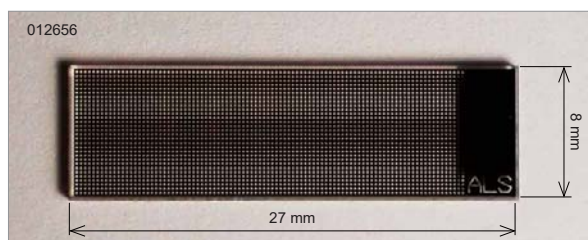

Catalog No.	Description
012655*	SEC-2F/3F Pt grid electrode for flow cell
012656*	SEC-2F/3F Au grid electrode for flow cell
012657*	SEC-2F/3F Carbon grid electrode for flow cell

* to be discontinued after stock is sold out

Schematic diagram of the grid

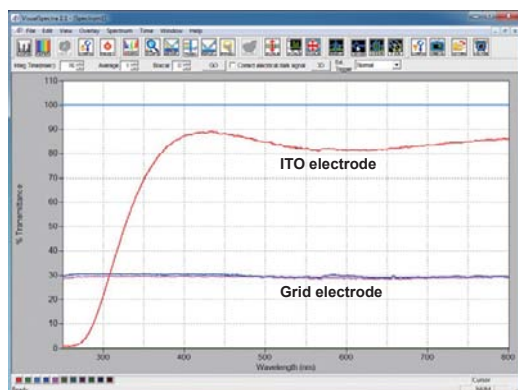
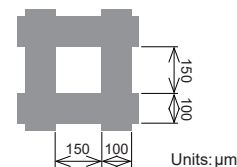

The light transmittance was measured using ITO electrode and grid electrodes (Au, Pt, and Carbon) on quartz glass as reference. The ITO electrode poorly transmits light in ultraviolet range. The transmittance is about 10% at 280 nm wavelength. For wavelength above 400 nm the transmittance is higher than 80%. Compared to quartz glass, the light transmission for the grid electrodes is about 30%, however it can be used in ultraviolet range.

Reference data:

The light transmittance of SEC-C Platinum mesh electrode is 50 – 55%.

PK-3 Electrode Polishing Kit

Polishing refreshes working electrode responses

The purpose of polishing is to remove redox reaction products accumulated on the working electrode surface. The polishing maintains the surface of working electrodes for CV/Flow cells and keeps them in a good condition.



With repeated electrochemical redox reaction experiments, adhesion of experimental products on the electrode surface can take place and the electron transfer rate is attenuated gradually. If electron transfer speed becomes slow, the difference between peak potentials for oxidation and reduction will broaden.

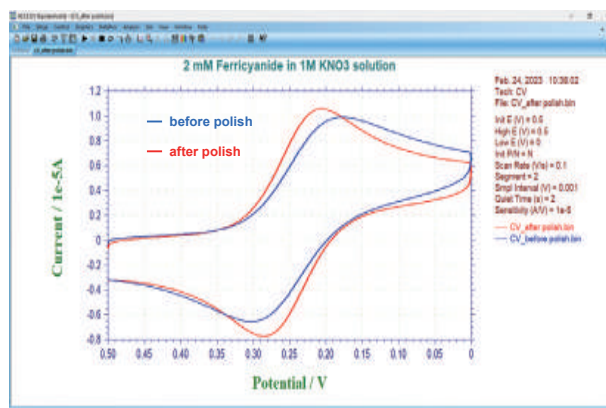

Glassy Carbon electrode

After refreshing the electrode surface by polishing, the electron transfer rate will increase again. As a result, the peak potential difference reduces and returns to an ideal CV.

Instructions to polish the working electrode surface with PK-3

STEP 1

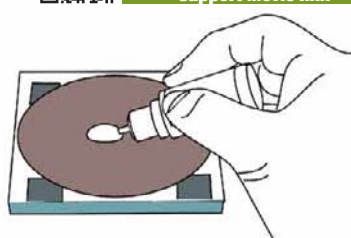

Prepare the glass plate, and put a few drops of polishing diamond on diamond polishing pad.

STEP 2

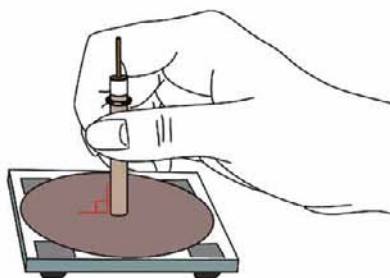

Hold the CV electrode perpendicular to the pad.

STEP 3

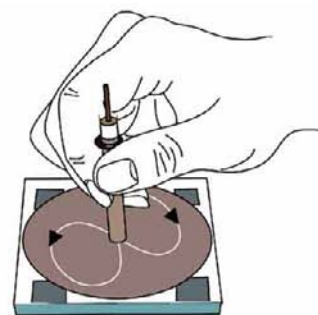

Polish in a circular motion, for 30 seconds to 2 minutes. Rinse the electrode surface with distilled water.

Catalog No.	Description		
013223	PK-3 Electrode Polishing kit		
	Contents	Qty	Purpose
012620	0.05 μm polishing alumina (20 mL)	1	For final polishing
012621	1 μm polishing diamond (10 mL)	1	For intermediate polishing
(012600)	Alumina polishing pad	10	For final polishing
(012601)	Diamond polishing pad	10	For intermediate polishing
013222	Replacement glass plate for PK-3	1	Glass plate to stick the polish pad
	Optional items		Purpose
013234	6 μm polishing diamond (10 mL)		For rough polishing
012600	Alumina polishing pad (20 pcs)		For final polishing
012601	Diamond polishing pad (20 pcs)		For intermediate polishing
012610	Coarse polishing pad (20 pcs)		For rough polishing
012611	Emery paper UF800* (20 pcs)		For PG and PFC electrode polishing

* When emery paper is used for polishing, use distilled water only. Polishing alumina and diamond can not be used for Pyrolytic graphite electrodes (PGE) and Plastic formed carbon electrodes (PFCE).

Glassy Carbon



Features

- High-purity
- Excellent stability as high as 3000 °C in vacuum
- Highly resistant against chemical corrosion
- Impermeable to gas and liquids
- Significant hardness / strength
- Good surface conditions after polishing
- Favorable electric conducting properties
- Low thermal expansion
- High resistance against inorganic and organic salts
- Good bio-compatibility
- Isotropic physical / chemical properties

We supply a broad range of Glassy Carbon products. Special shapes such as pipes, pot shape, etc. or custom dimensions and shape are available on request.

Characteristics of Glassy Carbon

Glassy Carbon has a quite unique structure. This material contains a random combination of basal planes and edge planes. The schematic on the right shows a model illustration introduced by G. M. Jenkins and K. Kawamura. GC is an outstanding material, which can be used for the electrodes in analytical chemistry, for electrochemical measurements, detection of high-speed liquid chromatography, biosensors, and others.

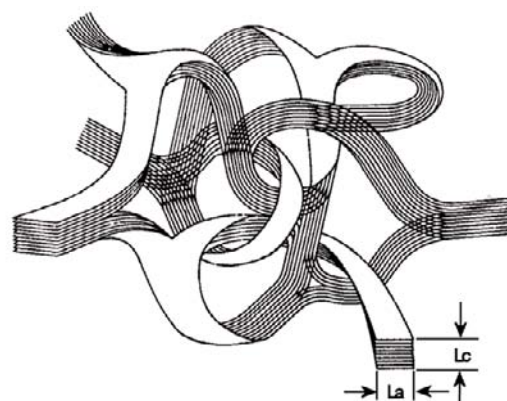

La: Intraplanar Microcrystalline Size, Lc: Interplanar Microcrystalline Size
G.M. Jenkins and K. Kawamura: Nature 231,175 (1971).

Size range available for customized products

Rod type: diameter from 1 to 10 mm; length up to 800 mm
Plate type: up to 300 x 300 mm; thickness of 0.3, 0.5, and 1 to 6 mm
Film type: up to 100 x 100 mm; thickness of 60, 100, and 140 μm
 Furthermore, drilling, cutting, and mirror polishing is possible.

Catalog No.	Description	Size
Rod type		
010761	R-1 Glassy carbon rod	dia 1 x 100 mm
010762	R-2 Glassy carbon rod	dia 2 x 100 mm
010763	R-3 Glassy carbon rod	dia 3 x 100 mm
Plate type		
012825	P-1 Glassy carbon plate	10 x 10 x 1 mm
012086	P-1 Glassy carbon plate	25 x 25 x 1 mm
012087	P-2 Glassy carbon plate	25 x 25 x 2 mm
012088	P-3 Glassy carbon plate	25 x 25 x 3 mm
Film type		
012089	F-100 Glassy carbon film	25 x 25 x 0.1 mm
Powder type (Spherical)		
012090	S-12 Glassy carbon powder	0.4 - 12 μm, 10 g
012091	S-20 Glassy carbon powder	10 - 20 μm, 10 g

Physical properties	Physical properties	
	Other than Film	Film
Shape		
Density	1.42 g/cm ³	1.54 g/cm ³
Ash content	< 100 ppm	
Upper Temperature Limit in vacuum	3000 °C	1000 °C
Porosity	0 %	
Gas Transmission Rate	10 ⁻⁹ cm ² /s	10 ⁻¹¹ cm ² /s
Hardness	230 HV1	340 HV1
Bending Strength	260 N/mm ²	210 N/mm ²
Compressive Strength	480 N/mm ²	580 N/mm ²
Young's Modulus	35 kN/mm ²	
Thermal Expansion Coefficient (20 - 200 °C)	2.6×10 ⁻⁶ 1/K	3.5×10 ⁻⁶ 1/K
Heat Conductivity (30 °C)	6.3 W/(m·K)	4.3 W/(m·K)
Electrical resistivity	45 μΩ·m	50 μΩ·m

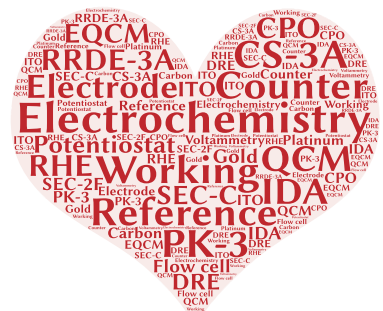
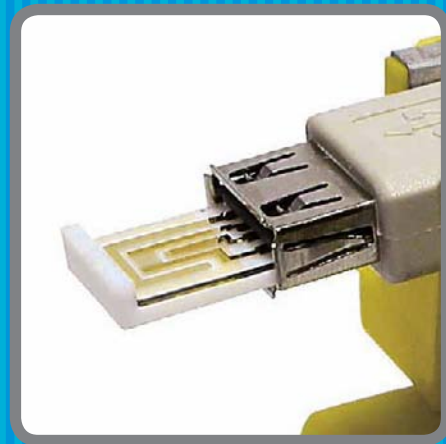
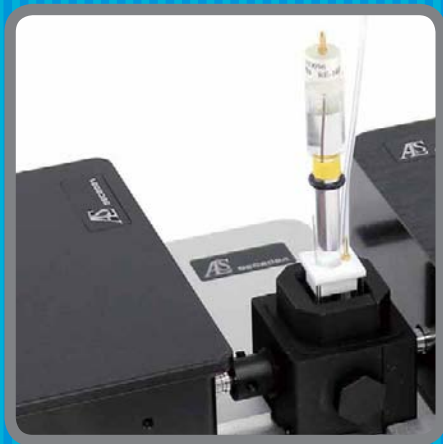

www.als-japan.com

Manufactured by:

ALS ALS Co., Ltd

Exclusive distributor:

BAS BAS Inc.

Address: 1-28-12, Mukojima, Sumida-ku, Tokyo 131-0033, JAPAN

Phone: +81-3-3624-0331 Fax: +81-3-3624-3387

URL: <https://www.als-japan.com/>

Email: sales@als-japan.com

ALS Co., Ltd is a member of BAS Inc.

Local distributor:



**C3 PROZESS- UND
ANALYSETECHNIK**

Peter-Henlein-Str. 20

D-85540 Haar b. München

Telefon 089/45 60 06 70

Telefax 089/45 60 06 80

info@c3-analysentechnik.de

www.c3-analysentechnik.de